

Vu⁺ zero 4K

User Manual

The True UHD Zapper

English

- Utmost speed and powerful 1.5GHz Dual Core 7000DMIPS
- 1 x Smartcard Readers (Xcrypt)
- 1 x Common Interface
- 4K UHD Hardware Decoding
- Single DVB-S2X or DVB-T2/C Tuner
- 2GB DDR4 RAM and 4GB eMMC Flash Memory
- Ethernet
- 1 x USB 2.0
- HDMI 2.0
- RS232 (External IR Sensor)
- SPDIF for digital bit stream out (optical)
- Power On/Off Switch
- EPG Support
- Automatic & Manual Service Scan supports
- Multiple LNB control (DiSEqC) supports
- Skin change supports
- Advanced Linux Operating System
- Various Plug-ins supports
- PVR KIT HDD (2.5")(optional)



Contents

(A) PRECAUTION!!!	4
(B) Packaging Contents	6
(C) Product Descriptions	7
(D) Conditional Access	10
(E) Remote Control	12
(F) Main Features	14
(G) Technical Data	15
I. Installation of Vu+	
1. Connecting Signal Cable	16
2. Connecting TV	17
3. Connecting Power	18
4. Power ON/OFF	18
II. First Time Installation (using Wizard)	
Step 1. Video Input Selection	19
Step 2. Video Mode Selection	19
Step 3. Language Selection	20
Step 4. Configuring Tuner Connection	20
Step 5. Installing Default Satellite List and Channel Scan	24
Step 6. Parental Control Option	26
III. Basic Operations	
1. Switching Channel	27
2. Volume Control	27
3. Selecting Audio Track	28
4. Subtitle	28
5. Teletext	29
6. Program Information (Infobar)	30
7. Channel List	31
8. Electronic Program Guide (Event View)	33
9. Timeshift	36
10. Recording	37
11. Recording Play	41
12. Managing Recording Files	42
13. Media Player	43
14. Plug-ins	44
15. Sleep Timer	45

IV. System Configuration

1.Main Menu	46
2.System Setup	47
1) Service Searching	47
A. Tuner Configuration	47
B. Loading Default Service Lists	48
C. Automatic Scan of Services	48
D. Manual Scan of Services	49
E. Tuner Configuration (for DVB-C)	51
2) System Configuration	53
A. A/V Settings	53
B. Language Selection	55
C. Customization	55
D. Selecting Time Zone	57
E. Hard Disk Set Up	58
F. Network Setup	58
G. Skin Change	61
3) Checking CAM	61
4) Parental Control	62
5) Factory Reset	64
6) Checking H/W and S/W Information	65
A. Service Information	65
B. System Information	66
7) Zero 4K to combine Plug	67
8) Remote Control Unit(RCU) Set-up	69
A. User Guide of Vu+ RCU	69
B. TV Code List	71
V. Copyright - GNU GPL	82
VI. Menu Structure	86
VII. Troubleshooting	87
VIII. Glossary	88

(A) PRECAUTION!!!

This Product has been designed and manufactured in compliance with EU consumer safety requirements (CE). Please read the following safety precautions carefully.

1. Connecting Power

- This product operates only in the range of AC100-240V and 50Hz/60Hz. Please check first your power supply to see if it fits this range.
- Please be noted that you need to disconnect from the mains before you start any maintenance or installation procedures.
- Make sure that the power cord is placed in a position where it is easy to unplug it from the mains in an emergency.

2. Overloading

- Do not overload a wall outlet, extension cord or adapter as this may cause electrical fire or shock.

3. Liquid

- This product is not water-proof and should not be exposed to dripping, splashing, or any type of liquid.
- No objects filled with liquid such as base shall be placed on the product.
- Please do not clean the product with wet cloth, which may cause a short circuit.
- No wet objects should be placed near the product.

4. Ventilation

- Allow a sufficient space between the product and other objects to make sure air ventilation of the product.
- Do not block the top or rear of the product with an object, which will close the ventilation holes and lead to a high temperature of the system. This may cause a failure of the product.
- Do not stack other electronic devices on top of the product.
- Do not insert any kind of pointed objects like screw, gimlet, etc. into the ventilation holes of the product. This will damage the product.

5. Connecting the Satellite Cable(S2X).

- Disconnect the power of the product before you connect the satellite cable to the product. Otherwise, it may cause damage to the LNB.

6. Grounding(S2X)

- The LNB must be earthed to the system earth for the satellite dish.

7. Location

- Place the product indoor.
- Do not expose the product to rain, sun or lightning.
- Do not place the product near any heat appliances as a radiator.
- Ensure that there is more than 10 cm distance from any electrical devices and wall.

8. Lightening, Storm or Not In Use.

- Unplug the product and disconnect the antenna cable during a thunderstorm or lightening, especially when left unattended and unused for a long period of time. This will prevent possible damages from power surges or lightening.

9. Replacement of Parts

- Unauthorized part replacements, especially by one who is not a qualified technician may result in damage to the product.
- Ensure that when part replacements are necessary qualified technicians perform the task using the components specified by the manufacturer.

10. Hard Disk Drive

- Do not move the product or turn the power off suddenly while the Hard Disk Drive (HDD) is still running. This may result in damage to the HDD and thus the system.
- The company shall not be liable for any corruption of data on the HDD caused by careless use or misuse of users.

11. Battery

- There is danger of explosion if batteries are incorrectly replaced.
- Replace batteries only with the same or equivalent type.



- "WEEE" Symbol instructions.

This product should not be disposed with other household wastes at the end of its working life.
Please separate this from other types of wastes and recycle it responsibly to promote the sustainable reuse of material resources. This will help prevent harm to the environment or human health from uncontrolled waste disposal.

(B) Packaging Contents

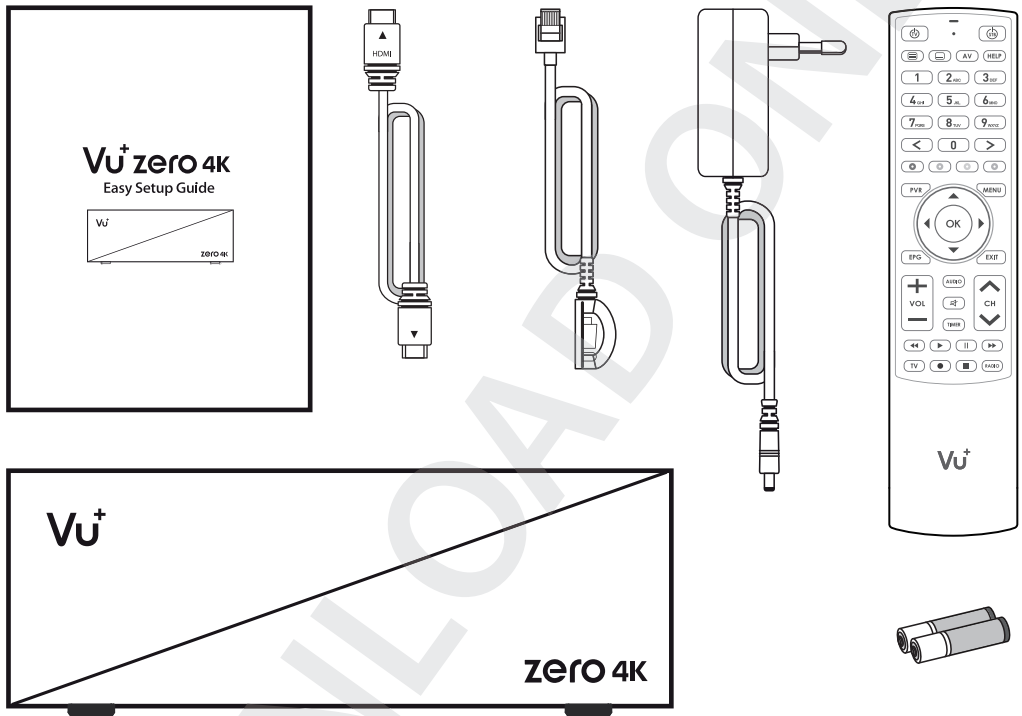

Please check all package contents before using your product.

- Standard RCU
- Easy Setup Guide
- HDMI Cable
- Power Adapter
- External IR Sensor
- RCU Battery

(C) Product Descriptions

● Front Panel

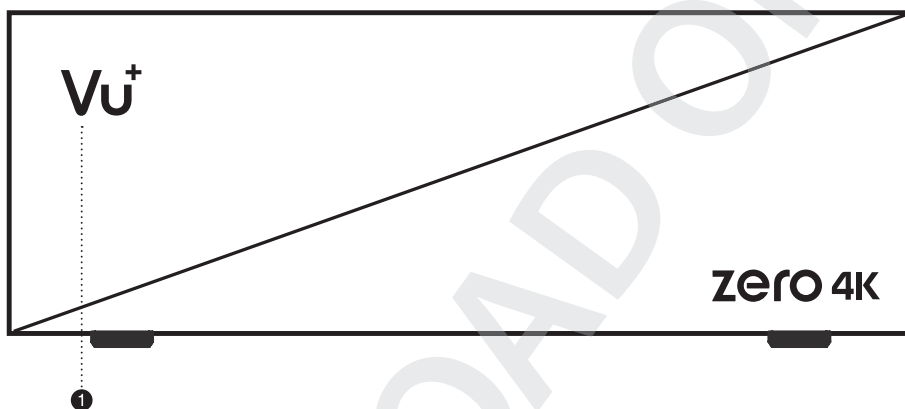

① Standby LED

● Rear Panel (DVB-S2X)

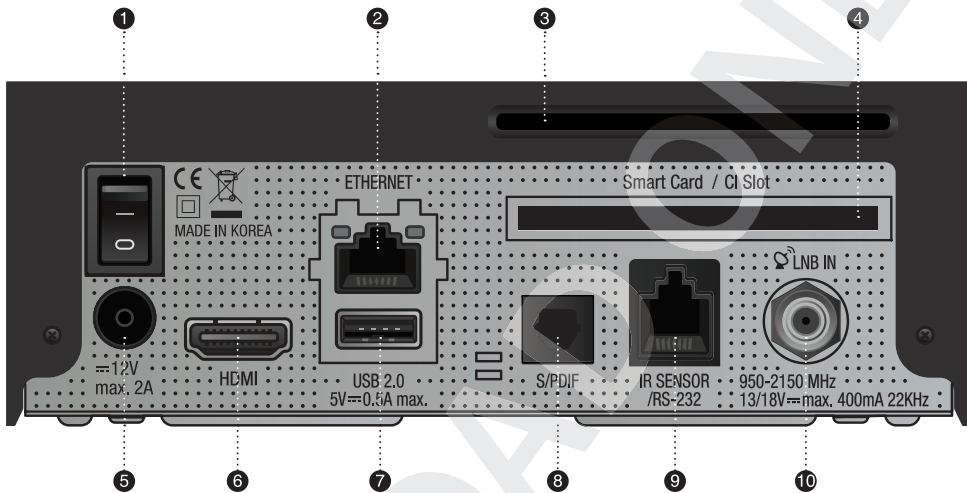

- ① **On/Off Switch**
Powers on/off.
- ② **Ethernet**
Connects the PC or another set top box of Vu+.
- ③ **Smartcard Reader Slot**
One Smartcard slot is provided.
- ④ **CI Module Slot**
One CI module slot is provided.
- ⑤ **Power Adaptor Input**
Connects the provided power adaptor for the main power.
- ⑥ **HDMI Out**
Connects to TV using a HDMI Cable for both audio and video signals.
- ⑦ **USB 2.0**
Connects the USB memory stick or external HDD.
- ⑧ **S/PDIF**
Connects to a digital audio system using S/PDIF cable.
- ⑨ **RS232**
RS232 data ports is provided.
- ⑩ **Tuner**
Single DVB-S2X Tuner available.

● Rear Panel (DVB-T2/C)

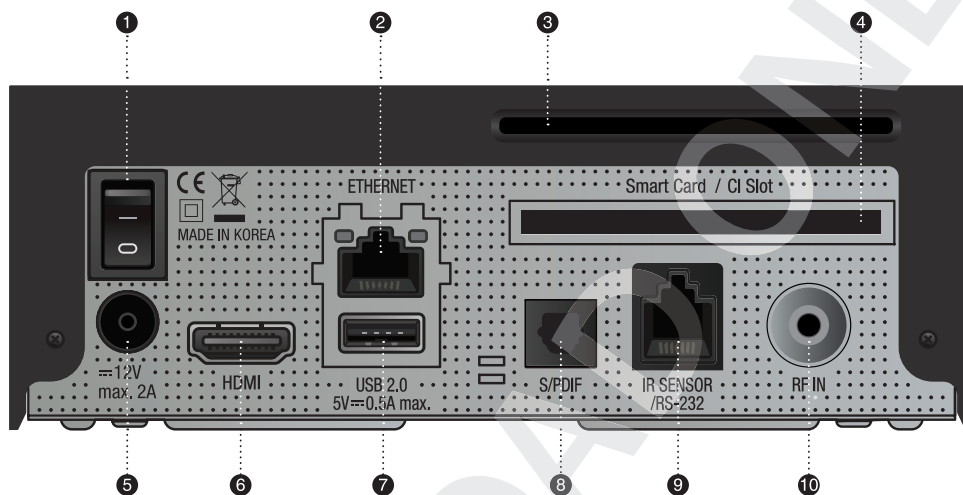

- ① **On/Off Switch**
Powers on/off.
- ② **Ethernet**
Connects the PC or another set top box of Vu+.
- ③ **Smartcard Reader Slot**
One Smartcard slot is provided.
- ④ **CI Module Slot**
One CI module slot is provided.
- ⑤ **Power Adaptor Input**
Connects the provided power adaptor for the main power.
- ⑥ **HDMI Out**
Connects to TV using a HDMI Cable for both audio and video signals.
- ⑦ **USB 2.0**
Connects the USB memory stick or external HDD.
- ⑧ **S/PDIF**
Connects to a digital audio system using S/PDIF cable.
- ⑨ **RS232**
RS232 data ports is provided.
- ⑩ **Tuner**
Single DVB-T2/C Tuner available.

(D) Conditional Access

Amongst the channels that are scanned via Vu+, some channels can be properly tuned in only with the corresponding Smartcard and/or CAM (Conditional Access Module). Vu+ ZERO 4K provides one Smartcard Reader slot and one Conditional Interface slot and users need to purchase those Smartcards and CAMs that are required for viewing such subscription based services.

Insertion of Smartcard

Vu+ supports Xcrypt. Users need to buy only these Smartcards without having to buy additional CAMs to watch those channels that are encrypted in Xcrypt.

- Open the door on the left side.
- Insert Xcrypt Smartcard as in the following instruction.
- Make sure that the Smartcard remains inserted while viewing.

NOTE : Insert the card while the smart card IC is downward.

Insertion

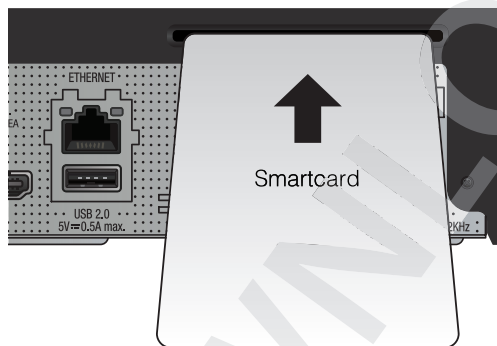

Insertion of CAM (Conditional Access Module)

There are several Conditional Access Systems (CAS), other than Xcrypt that Vu+ supports. To be able to watch channels that are encrypted in such CAS as Nagravision, NDS, Irdeto, Viaccess, etc, users need to purchase a CAM that is corresponding to each CAS, as well as Smartcard to decrypt those encrypted channels.

- Insert a Smartcard into the CAM as in the below picture.
- Once the Smartcard inserted into the CAM, insert the CAM into the CI slot.
- Make sure that the CAM remains inserted while viewing.

Insertion

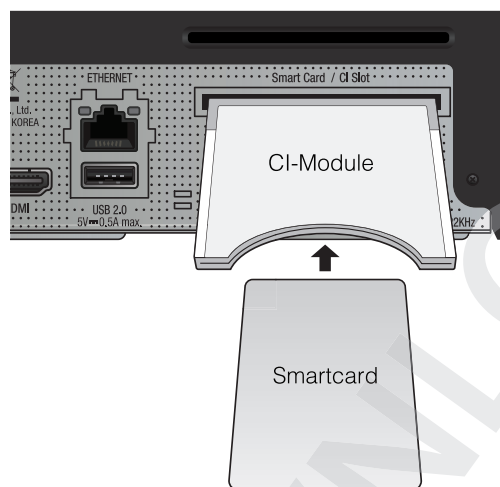

(E) Remote Control

Vu+ ZERO 4K remote control (RCU) is a universal one that can be used for TV and STB both.

① TV Power

Once configured for TV remote control, this button is for TV power on/off.

② STB Power

When the STB is turned on, normal press of this button puts the STB into standby mode instantly. When the STB is turned off, normal press of this button turns the STB on instantly. Long press activates Standby /Restart menu.

③ Teletext

Displays the teletext information of the current channel if the channel provides subtitles.

④ Help

Displays major important operation methods of Vu+. This provides users with a quick guide of using Vu+.

⑤ Subtitle

Displays the subtitle of the current channel if the channel provides subtitle.

NOTE : when Teletext is activated,  key is also used when toggling between the Teletext page and the live mode.

⑥ AV

This button is used when selecting video source of TV.

⑦ Numeric Keys

Enters a channel number or numbers required to be input according to menu options.

⑧ Color Keys

Each key is assigned a specific function that may be different in each menu.

- Red – mainly used for REC, Cancel, etc.
- Green – mainly used for OK
- Yellow

⑨ Recording List

Displays the list of recordings stored on the internal HDD if any.

⑩ Menu

Displays the main menu.

⑪ Navigation Keys

Navigates up/down and left/right on the menu options. Up/down keys are used to call up the channel list.

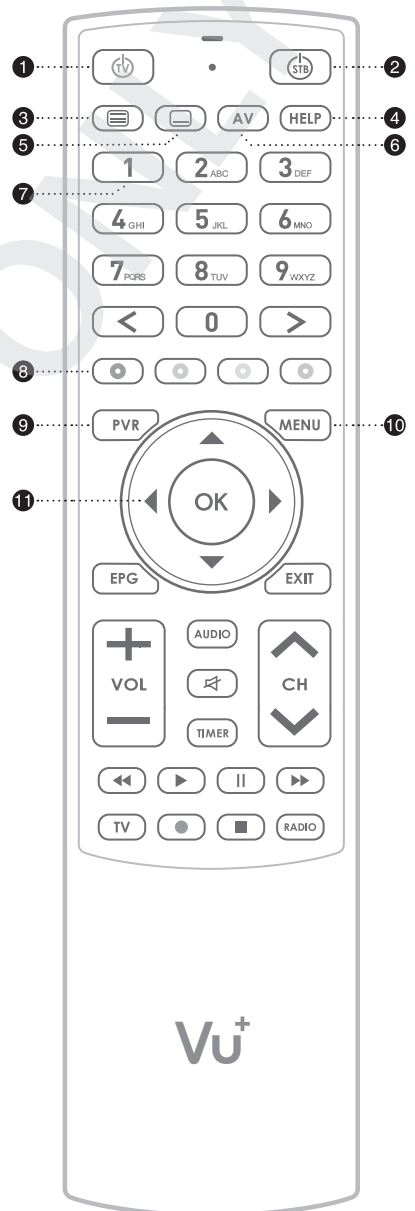

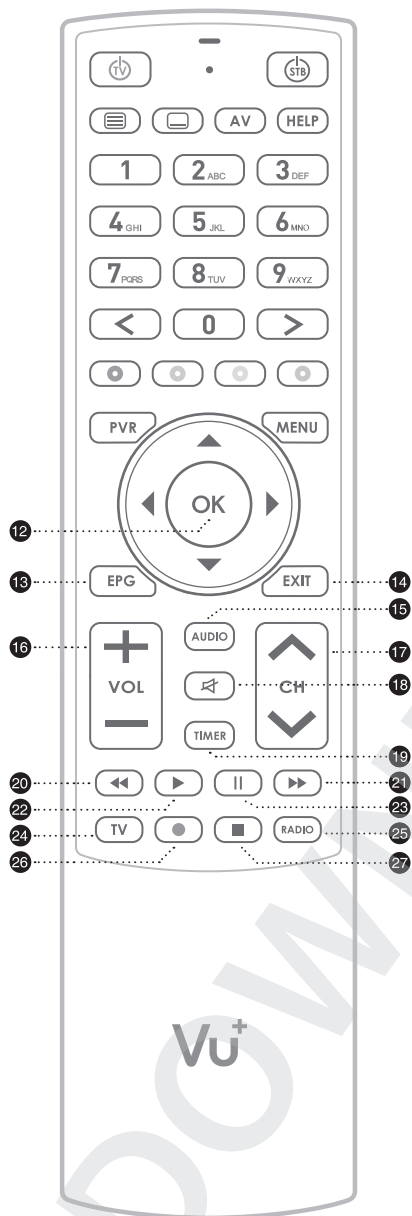

- ⑫ **OK**
Confirms the selected menu option.
- ⑬ **EPG**
Displays the Electronic Program Guide (EPG) information if provided.
- ⑭ **EXIT**
Exits the current menu option into the live mode, or switches one step back of the menu.
- ⑮ **Audio**
Displays the audio track option to choose (e.g. ACS, Stereo).
- ⑯ **Volume + / -**
Adjusts the audio volume.
- ⑰ **Channel + / -**
Navigates through the scanned channel list.
- ⑱ **Mute**
Silences the audio temporarily.
- ⑲ **Timer**
- ⑳ **Fast Rewind**
Fast rewinds at up to 128 times faster than the normal speed (x2 / 4 / 8 / 16 / 32 / 64 / 128).
- ㉑ **Fast Forward**
Fast forwards at up to 128 times faster than the normal speed (x2 / 4 / 8 / 16 / 32 / 64 / 128).
- ㉒ **Play**
Plays the selected file (e.g. recording) at the normal speed.
- ㉓ **Pause**
Pauses the live program or recording play.
- ㉔ **TV**
Displays the TV Channel list.
- ㉕ **Radio**
Displays the Radio channel list.
- ㉖ **Recording**
Displays instantly the recording menu.
- ㉗ **Stop**
Stops playing of a recording and goes to the live mode.

(F) Main Features

- Utmost speed and powerful 1.5GHz Dual Core 7000DMIPS
- 1 x Smartcard Readers (Xcrypt)
- 1 x Common Interface
- 4K UHD Hardware Decoding
- Single DVB-S2X or DVB-T2/C Tuner
- 2GB DDR4 RAM and 4GB eMMC Flash Memory
- Ethernet
- 1 x USB 2.0
- HDMI 2.0
- RS232 (External IR Sensor)
- SPDIF for digital bit stream out (optical)
- Power On/Off Switch
- EPG Support
- Automatic & Manual Service Scan supports
- Multiple LNB control (DiSEqC) supports
- Skin change supports
- Advanced Linux Operating System
- Various Plug-ins supports
- PLUG HDD (2.5")(optional)

(G) Technical Data

Vu+ Technical Specifications		
Front Panel	Display	Status LED (white)
Rear Panel	Power switch	1
	RF input	Single DVB-S2X or DVB-T2/C Tuner
	CI Slot	1
	Smart Card Slot	1
	Ethernet	1
	USB 2.0	1
	Video/audio output (digital)	1 X HDMI
	Audio output (digital)	Standard optical (SPDIF)
	RS232 (Ext. IR slot)	1
Power	Adaptor	AC 100-240V / 50-60Hz
	"Power consumption Max./typ. Operation / Standby"	24 / 15 / 0.5W
RF	RF range (DVB-S2,S / DVB-C)	950-2,150 MHz / 51 - 858 MHz
	Modulation, FEC, de-multiplexer	DVB-S/DVB-S2/DVB-S2X/DVB-C Standard
Video	Video resolution	CCIR 601 (720 x 576 lines), 576p, 720p, 1080p, 2160p
	Video decoding	MPEG-2, MPEG-4, H.265/HEVC compatible
	S/N	> 53dB
Audio	Audio decoding	MPEG-4(AAC-HE), MPEG-1, Layer1,2 and 3(MP3), SRS(3D sound), WMA, AC4
	Sampling rate	16/32/44.1/48 kHz
	S/N	> 65dB
LNB	LNB supply (horiz./vert.)	14/18V / Max. 400mA
	Control signal	22kHz ; ToneBurst ; DiSeqCTM1.0/1.1/1.2
General	Dimensions(W x H x D)	140 x 108 x 50mm
	Weight	318g

NOTE : ⓘ means Remote control operation order.

I. Installation of Vu+

This chapter will guide you through the whole installation process of Vu+. Please read each section carefully to make sure that the system runs properly.

1. Connecting Signal Cable

Vu+ ZERO 4K is designed two models. mounted DVB-S2X tuner or DVB-T2/C(Cable) Tuner.

1) DVB-S2X Tuner

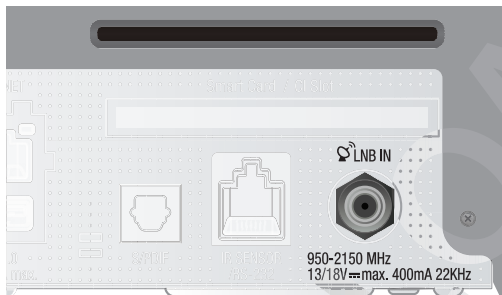

2) DVB-T2/C Tuner (Cable)

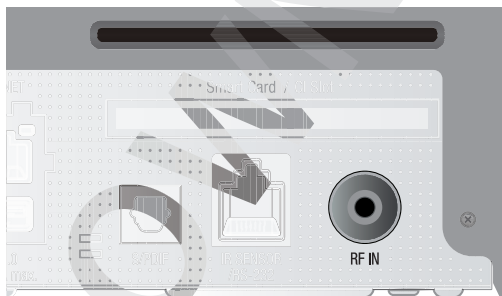

2. Connecting TV

Vu+ provides a variety of audio/video connection methods.

1) Connecting TV via HDMI cable

For the sake of the best picture quality, especially for digital TV, HDMI connection is recommended. Most HDTVs have HDMI connectors to ensure the highest picture quality. In the rear panel of Vu+ one HDMI connector is available for this purpose. Connect your TV to Vu+ using a HDMI cable as follows.

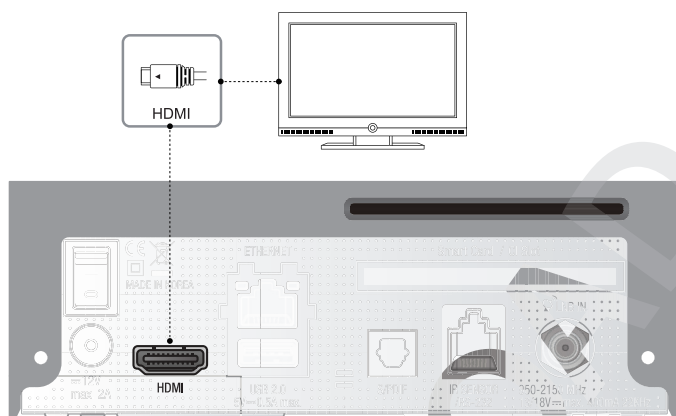

2) Connecting TV via S/PDIF connection

Vu+ provides S/PDIF connectors. When you have an A/V receiver with S/PDIF digital audio input, this connection is recommended to enjoy the best audio quality.

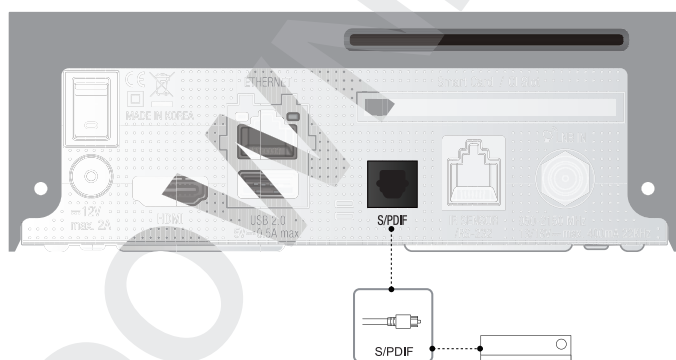

3. Connecting Power

A power cord is provided as one of the basic accessories of Vu+.

- Connect the power cord to the connector at the rear panel of Vu+.
- Connect the power cord to a power outlet.
- Turn on the power switch at the rear panel.

NOTE : DC input condition

- 12V  2A

NOTE :  means Remote control operation order.

4. Power ON/OFF

 : Press Power  key / Press MENU  key > Select Idle Server Mode/Reset]

There are several ways to turn your Vu+ ON or OFF.

• Complete Power Shutdown

There is a Power Switch in the rear panel and once it is ON, you do not need to turn it on or off each time. It takes a longer time to boot the system if you turn it off by this switch.

• Idle Server Mode

POWER key is normally used to turn the power of Vu+ on or off. If you press **POWER** key, it instantly switches your Vu+ off or on. In this mode, the system is not completely shutdown and thus it takes a shorter time to turn it on and off.

• Standby Mode [: Menu > Idle Server Mode/Restart > Standby]

Standby is used to reduce the standby power consumption. Vu+ is designed to be energy-efficient and to guarantee the power consumption to be under 1W in the standby mode.

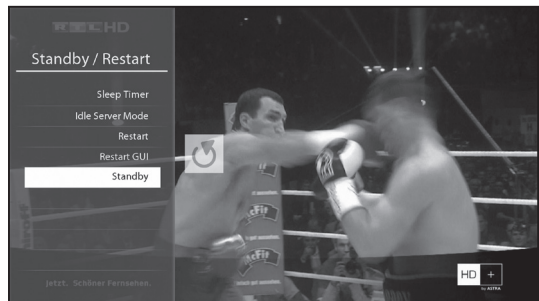
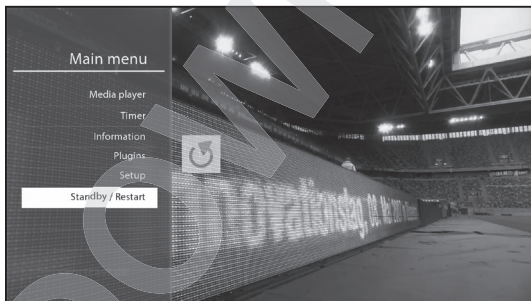

II. First Time Installation (using Wizard)

When you turn on Vu+ for the first time after purchase, an installation wizard will begin step by step.

NOTE : OK key is used for confirmation and turns to the next step. Press EXIT key to return to the previous page.

Step 1. Video Input Selection

Vu+ provides various I/O for video connection and here you can choose the main video connection port for your Vu+. Use UP/DOWN key to scroll up and down to find the video connection port you want.

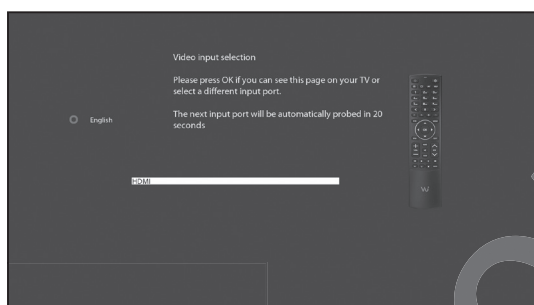

Step 2. Video Mode Selection

Vu+ provides various modes for video and here you can choose the video mode for your Vu+. Use UP/DOWN key to scroll up and down to find the video mode you want.

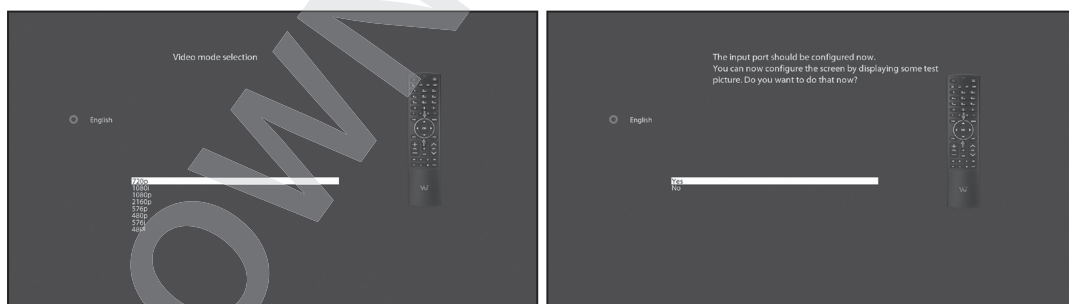

Step 3. Language Selection

Vu+ provides various languages and here you can choose the main language for your Vu+. Use UP/DOWN key to scroll up and down to find the language you want.

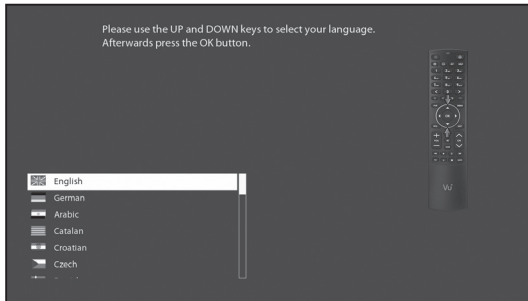

Step 4. Configuring Tuner Connection

From now on you need to configure the tuner connection. You have two options:

- Use wizard to set up basic features
- Exit wizard

You are strongly recommended to use wizard as it is designed to guide you through the configuration process.

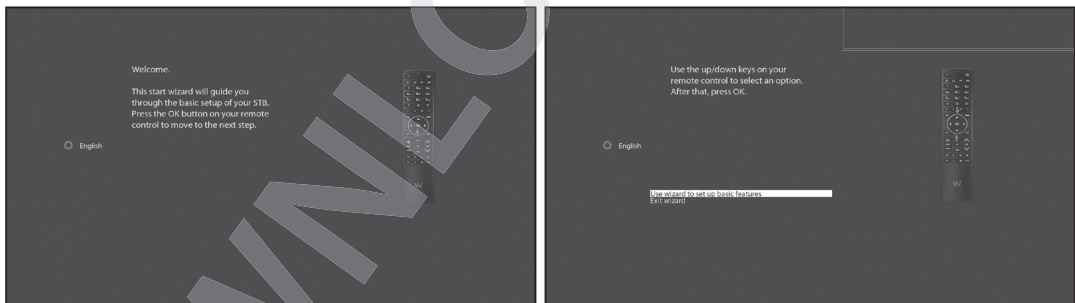

A. Configuring Tuner DVB-S2

NOTE : If DVB-S2 tuner is mounted, read the following instructions.

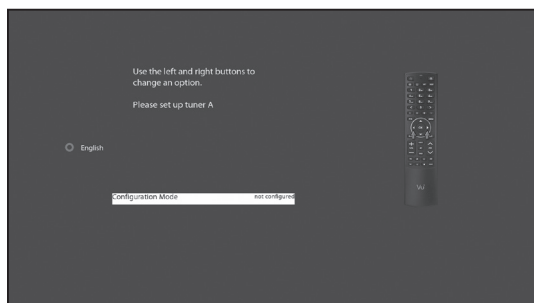

Using LEFT/RIGHT key, you can choose one of the following Configuration Modes:

- Not configured
- Simple
- Loop through to: mode to make the LNB1 be internally connected to the LNB2 in.
- Equal to: mode to use the same configuration as that of Tuner B.
- Advanced: for an advanced user configuration.

If you choose Simple configuration mode, the following picture will appear.

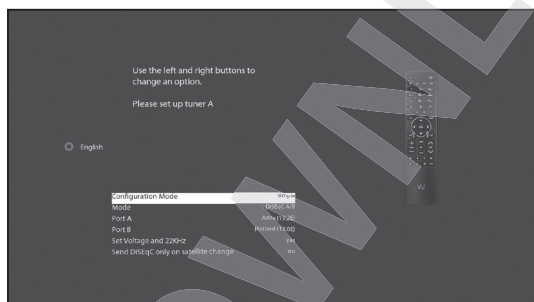

The five modes are available for the satellite cable connection between LNB and your Vu+ as below :

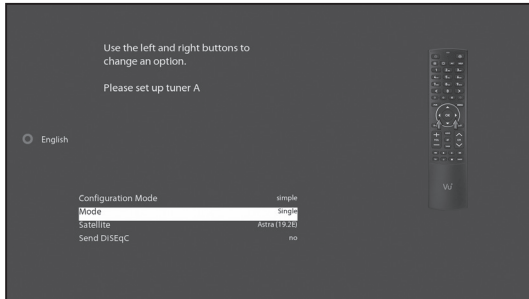

- **Single**

This option is used to receive a single satellite with a single LNB. The cable from LNB is directly connected to Vu+.

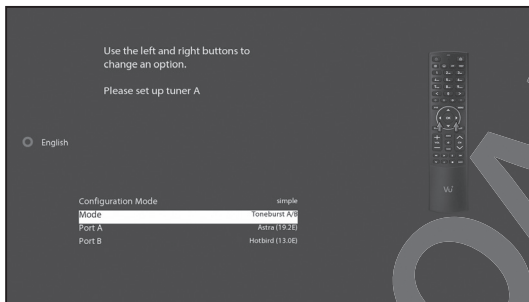

- **Toneburst A/B**

This option is used if you want to receive two satellites using a Toneburst switch.

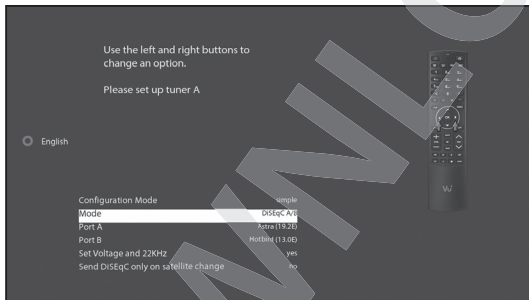

- **DiSEqC A/B**

This option allows you to configure two satellites in Port A and Port B.

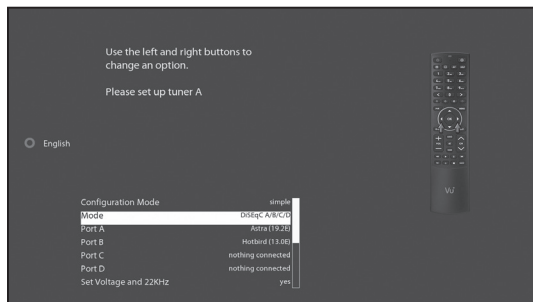

• DiSEqC A/B/C/D

This option allows you to configure four satellites in Port A, Port B, Port C and Port D.

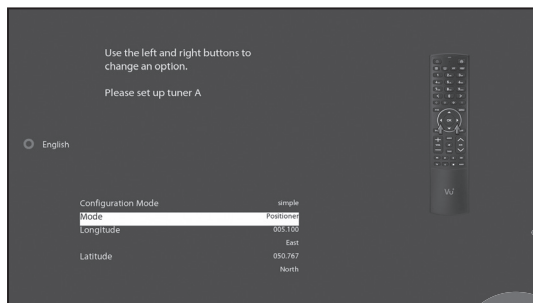

• Positioner

This option is used when you have a motorized satellite antenna.

B. Configuring Tuner DVB-C

NOTE : If DVB-C tuner is mounted, read the following instructions.

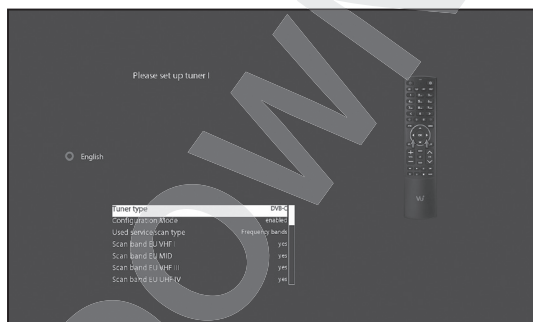

• Configuring DVB-C Tuner

This option allows you to decide whether to scan each of the various scan band in the list.

Step 5. Installing Default Satellite List and Channel Scan

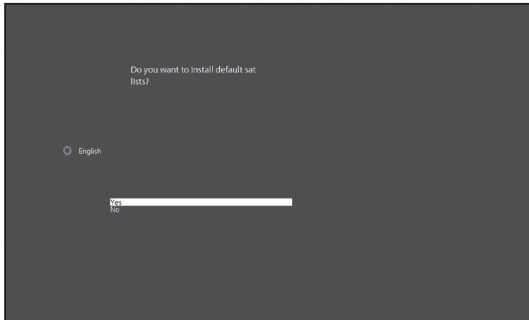

- **Installing default channel list**

Here you can decide whether to install the default channel lists or not.

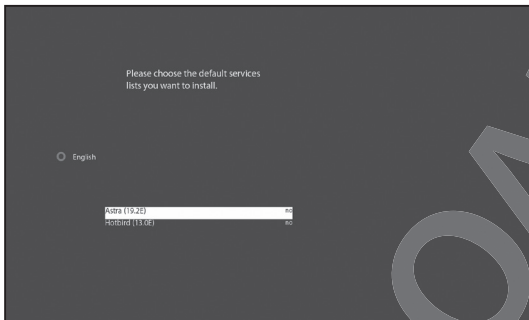

- **Choosing Satellite Service List**

With the available satellite service lists on the screen, you can choose to get which satellite service lists you want by using LEFT/RIGHT key.

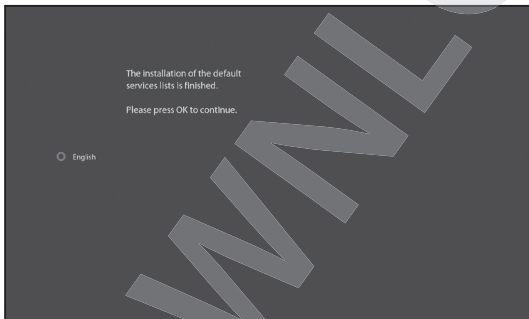

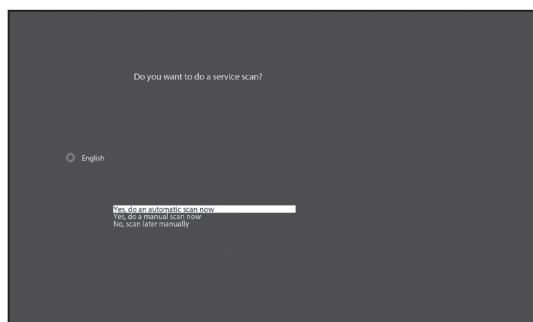

- **Selecting Scan Mode - Automatic Scan / Manual Scan**

Channel scanning is possible either in Automatic Scan mode or Manual Scan mode.

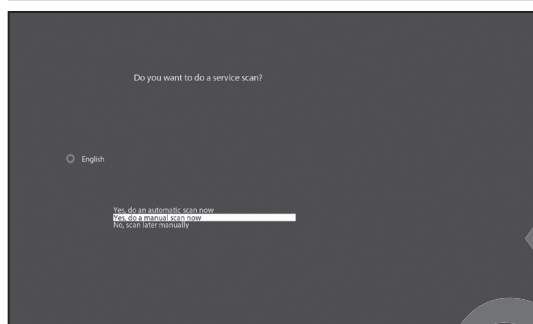

- **Automatic Scan**

If you choose Automatic Scan, you will be asked whether to erase all the existing channels before scanning.



- **Manual Scan**

You can select the type of scan between Complete and Single Transponder.

Press **OK** key to initiate the channel scan.

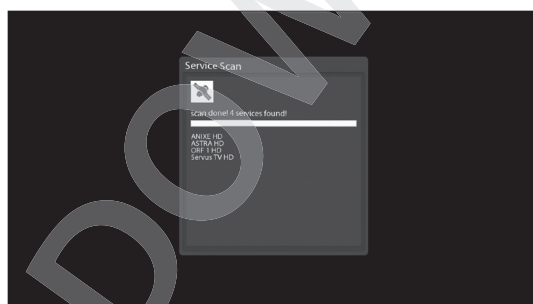

- **Channel Scanning**

The scanned channels will be displayed if the previous configurations have been done correctly.

Step 6. Parental Control Option

Here you can choose whether to enable the parental control option. If you press **OK** key, you will be asked to enter PIN number.

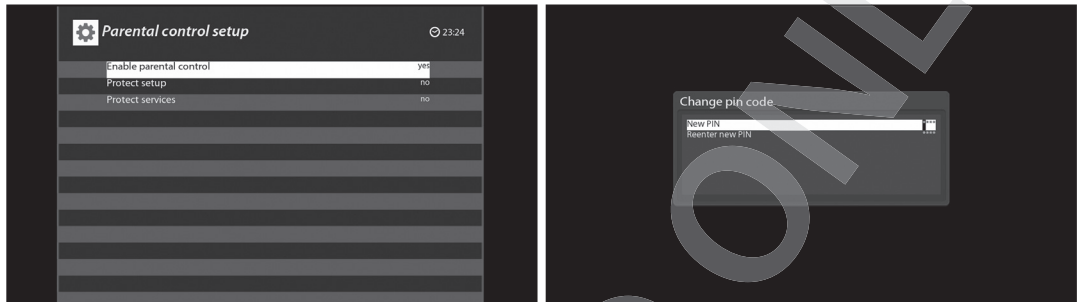

III. Basic Operations

1. Switching Channel

[i] : Press NAVIGATION (▲) / (▼), CHANNEL (▲) / (▼) key / Press (◀) / (▶) key to move to the next channels]

Vu+ offers various channel zapping methods. You can switch the current channel by pressing.

- **UP/DOWN** key

If you press **UP** or **DOWN** key, *Channel Selection* menu appears.

You can move up and down to select the channel that you want to tune into.

- **LEFT/RIGHT** key

If you press **LEFT** or **RIGHT** key, the previous or subsequent channel of the current channel is tuned in.

- **CHANNEL +/-** key

If you press **CHANNEL +** or **-** key, this will call up the *Channel Selection* menu.

- **Channel Number**

Enter a channel number, and it will instantly tune into the channel.

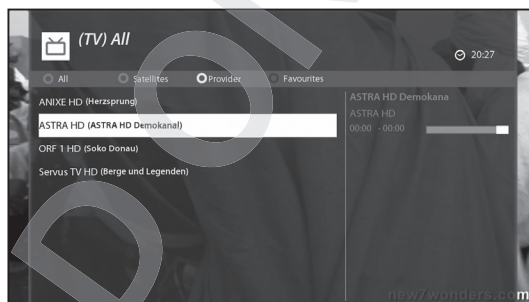

2. Volume Control

[i] : Press VOLUME (+) / (-) key]

You can adjust the audio volume by pressing **VOLUME +/-** key. You can also mute or unmute the audio temporarily by pressing **MUTE** (🔇) key.



3. Selecting Audio Track

[**i**] : Press AUDIO (AUDIO) key]

You can check what audio tracks are available to choose by pressing **AUDIO** key.

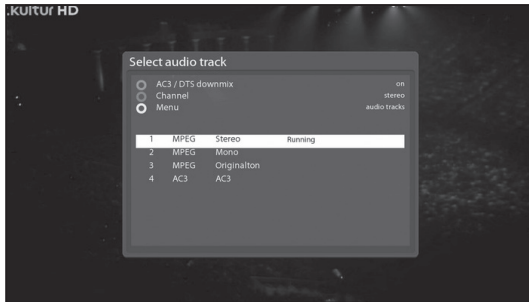

By using **UP/DOWN** key and **COLOR** key, you can select a different audio language or Stereo sound.

NOTE : Available options on this menu will differ depending on the service.

4. Subtitle

[**i**] : Press SUBTITLE (SUBTITLE) or Press MENU (MENU) key > Subtitle]

You can view the subtitle of the current program if the program provides the subtitle. Press **SUBTITLE** (SUBTITLE) key and *Subtitle selection* menu appears as below.

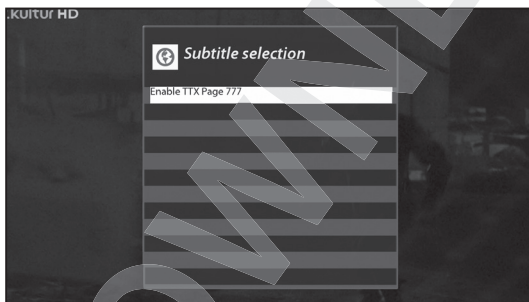

Available subtitles, if any, will display. By using **UP/DOWN** key navigate the list to select a subtitle that you want to play and press **OK** key to activate it.

5. Teletext

(**i**) : Press TELETEXT (**☰**) key]

You can call up Teletext information by pressing TELETEXT (**☰**) key. It will take some time to load all the information.



You can navigate through the Teletext page by using UP/DOWN key to select a text page. Also, just simply enter the page number that you want to read.

- **MUTE** (**🔇**) key
Once you activated Teletext, you can toggle between the live mode and the Teletext page by pressing **MUTE** (**🔇**) key instantly. In this case, loading of the Teletext page takes place instantly.
- **VOLUME +** key
If you want to enlarge the page, press **VOLUME +** key.

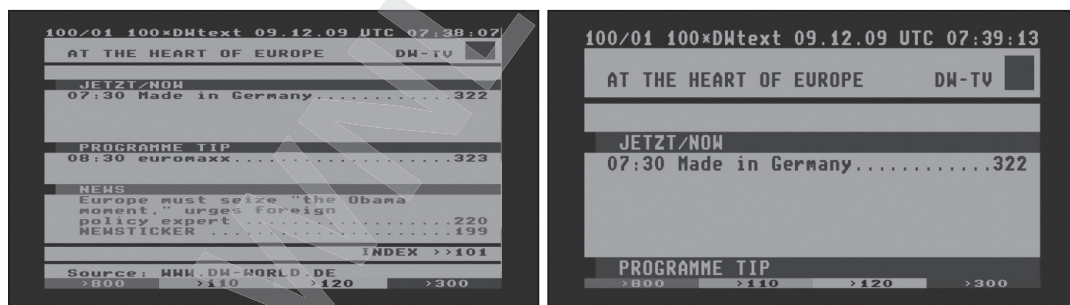

- **VOLUME** – key

If you want to reduce the page size, press **VOLUME** – key.

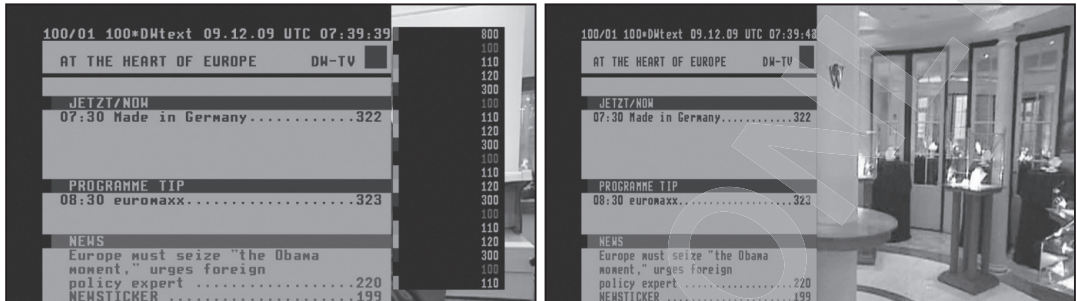

6. Program Information (Infobar)

[**i**] : Press OK (**OK**) key

Whenever you change the channel, infobar is always displayed for 5 seconds (default setting). Infobar is designed to provide you comprehensive information of the channel that you are currently watching.

- Press **OK** key to call up infobar.

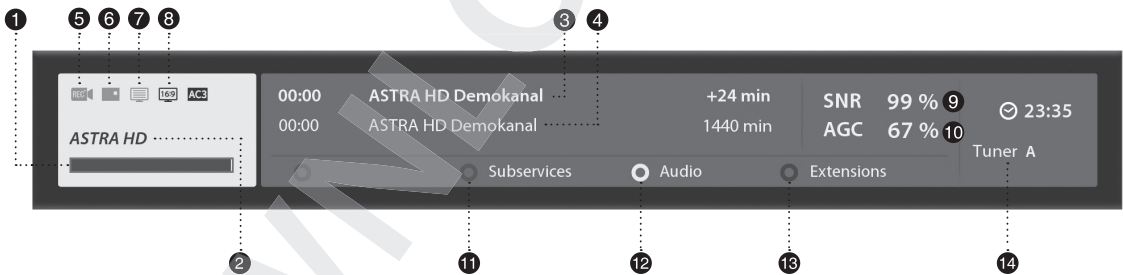

- ① Remaining time of the current program.
- ② The name of the current channel.
- ③ The current program.
- ④ The next program.
- ⑤ REC : Highlighted in red when recording is in progress.
- ⑥ CAS (■) : Encrypted program.
- ⑦ Teletext (≡) : Highlighted when the program provides Teletext.
- ⑧ 16:9 : Screen ratio.

- ⑨ SNR (Signal to Noise Ratio) : Signal Level.
- ⑩ AGC (Automatic Gain Control) : Signal Strength.
- ⑪ GREEN : to call up Subservices, if available.
- ⑫ Audio : to display available audio tracks.
- ⑬ Extensions : to call up a Picture in Picutre.
- ⑭ Tuner A : The tuner being used for the current channel.

7. Channel List (Channel Selection Menu)

[**i**] : Press NAVIGATION (▲) / (▼), CHANNEL (▲) / (▼) key]

If press UP/DOWN key, this will activate *Channel Selection* Menu as below.
Four types of the channel lists are available to help you manage your channel selection.

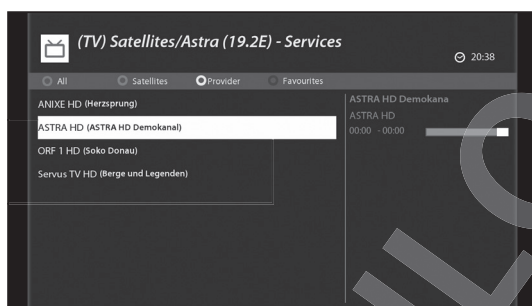

- RED displays the list of all scanned channels.

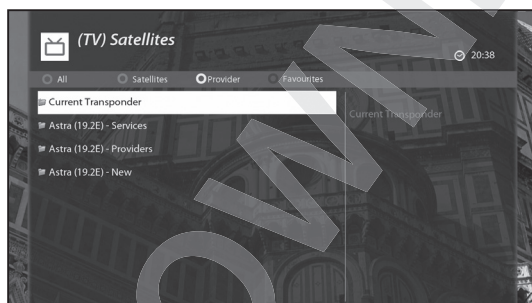

- GREEN displays the list of all scanned satellites. Per each satellite, channels are arranged according to *Services*, *Provider*, and *New*.

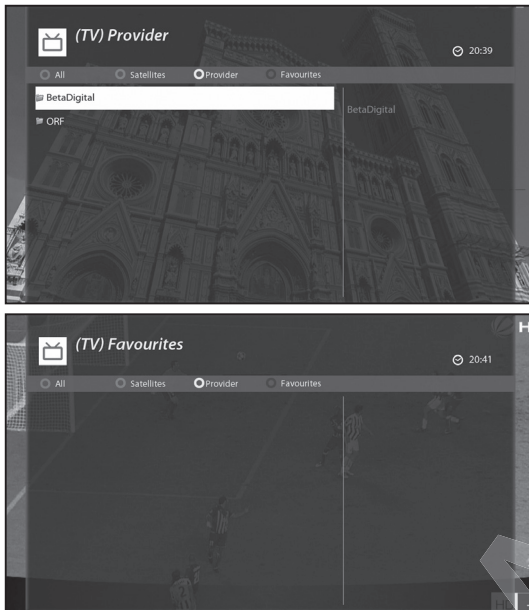

- **YELLOW** displays the list of providers.

- **BLUE** displays the list of your favorite channels.

In order for you to add certain channels to this *Favourites* list,

- Call up the *Channel Selection* list by pressing **UP** or **DOWN** key.
- Go to the *All* list by pressing **RED** key.
- Select the channel that you want to add to the *Favourites* list.
- Press **MENU** key on the selected channel and the following menu appears.

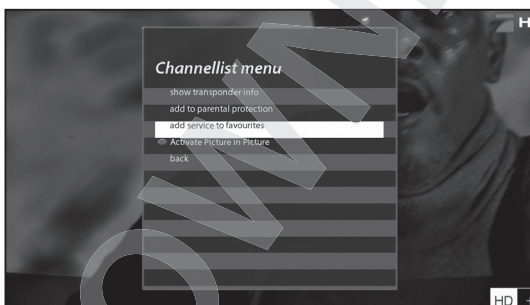

- Choose “*add service to favourites*” and press OK key.
- Go to the *Favourites* list by pressing **BLUE** key to confirm that the selected channel is correctly included in the list.

8. Electronic Program Guide (Event View)

 : Press EPG  key]

The Electronic Program Guide (EPG) displays the program information of each channel, if provided, in time and date order. You can view the detailed program information by pressing **EPG** key and the following menu, *Eventview* appears.

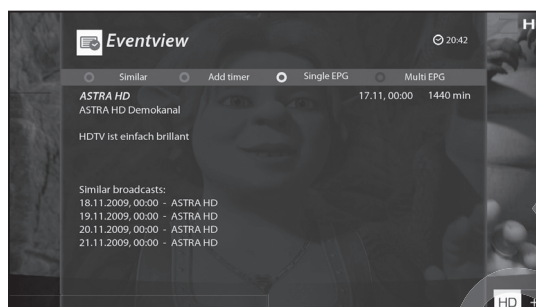

Detailed information of the current channel will be displayed on EPG. On this menu, three options are provided.

- **RED (Similar)**

This option helps you find similar programs. If there are one or more programs that are similar to the current program, *EPG Selection* window displays them as below.

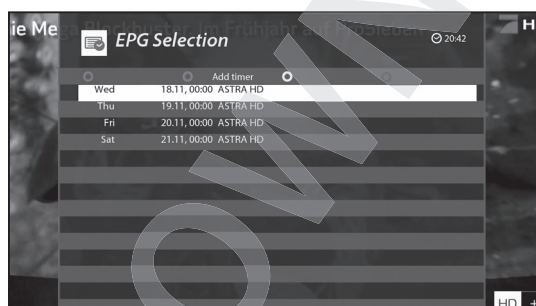

• GREEN (Add Timer)

If you press **GREEN** key, *Timer entry* menu appears as below. This option is used to set up a new timer for recording or zapping.

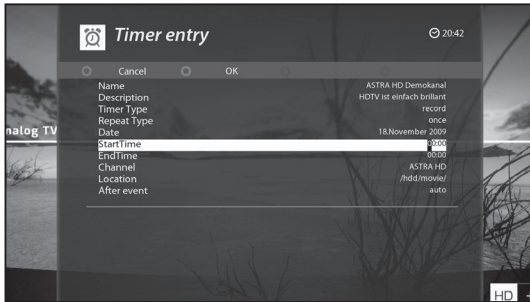

- Name

Displays the name of the selected program.

- Description

Displays a short description of the selected program.

- Timer Type

- Select **Zap** for channel tuning reservation.
- Select **Record** for recording reservation.

- Repeat Type

- Select **Once** for one time of zapping or recording reservation.
- Select **Repeated** for repeated zapping or recording reservation.
- Repeats - This option is given only when you selected "**Repeated**" in the Repeat Type. You can reserve zapping or recording per Daily / Weekly / Mon-Fri / User-defined.

- Date

Displays the current date. This entry is on when you selected **Once**, in the Repeat Type.

- Start Time

You can set the time to begin recording or zapping.

- End Time

You can set the time to end recording or zapping

- Channel

This entry allows you to change the channel. Press **LEFT/RIGHT** key to call up *Channel Selection* menu. You can select a different channel from this list using this option. To return to *Timer entry* menu, press **EXIT** key.

- After event

This option allows you to choose from auto, do nothing, go to Idle Server Mode, and go to standby after the timer event is done.

• YELLOW (Single EPG)

Press **YELLOW** key while *Eventview* menu is on, to call up the program event schedules of the selected channel.

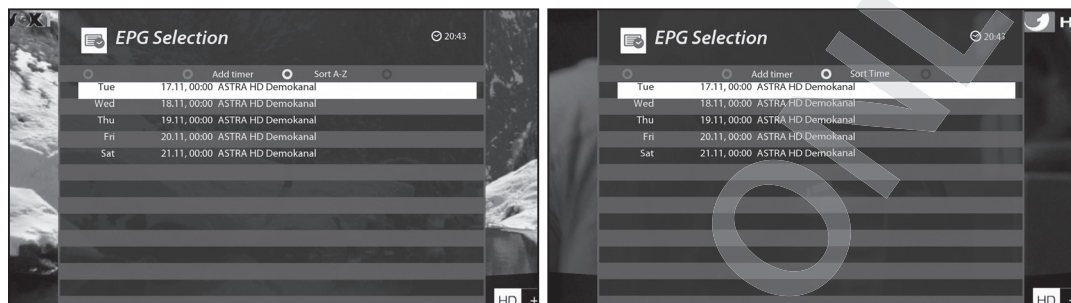

In this state, you can sort the list according to A-Z order or Time by pressing **YELLOW** key.

NOTE : To add a timer for recording or zapping, press **GREEN** key.

• BLUE (Multi EPG)

Press **BLUE** key to activate *EPG Selection Multi* window.

- You can move the previous or next program within the same channel by using **YELLOW** key (Previous)/ **BLUE** key (Next).

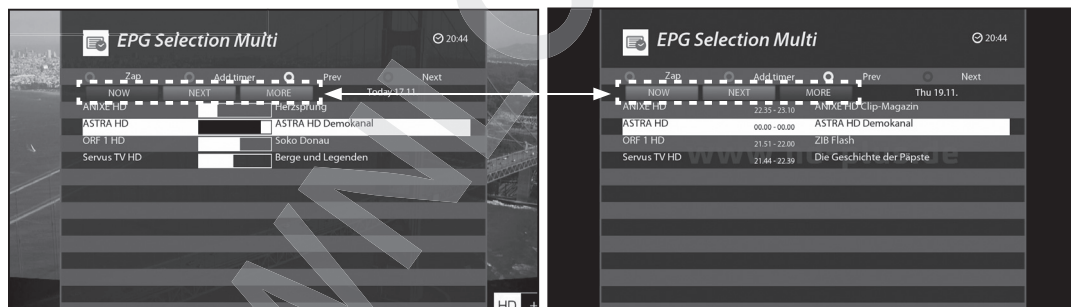

NOTE : Not all channels provide EPG information and thus in case of no EPG data, nothing will be displayed except for the channel name.

- You can switch to another channel by using **UP/DOWN** key.
- **RED** key is used to instantly tune into the selected channel.
- **GREEN** key is used to reserve recording or zapping of the selected program.

9. Timeshift

[**i**] : Press **PLAY** (▶) or **PAUSE** (⏸) key]

For your information, Timeshift is an instant recording of the current program that you are watching. Press **PLAY** or **PAUSE** key, it will instantly pause the audio and video of the program, and a small window displaying elapsed time information will appear on the left upper side of the screen as below.



In this state, Timeshifted recording is running until you press either **PLAY** or **PAUSE** key again. You can restart viewing of the program.

If you want to stop Timeshifted recording and to return to the live mode, press **STOP** key.

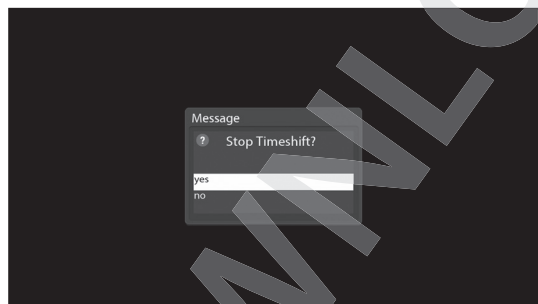

You will be asked of **Yes** or **No** to stop Timeshift.

NOTE : What is different from normal recording is that Timeshifted recording is not meant to be stored on HDD. If you stop Timeshift, you cannot replay the Timeshifted recording.

10. Recording

Vu+ ZERO 4K supports multiple recordings up to 16 at the same time.

1) Instant Recording

[**i**] : Press REC (**o**) key]

Press REC (**o**) key to start the recording of the current program.



Five recording options are given.

- Add recording (stop after current event)

This option is used when you want to end recording when the current program ends.

- Add recording (enter recording duration)

This option is used when you want to manually set the length of recording by entering a certain number as below:

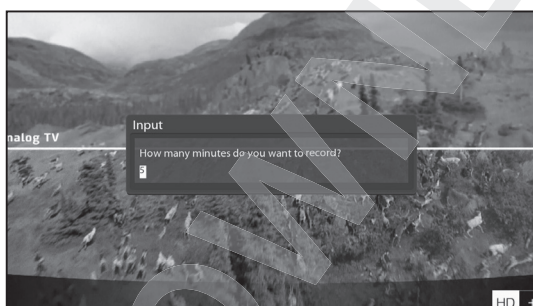

- Add recording (enter recording end time)

This option is used when you want to define a certain date and time when the recording is stopped.



- Add recording (indefinitely)

This option is used when you want to keep recording running without a specific end time. Recording will continue unless you stop it.

- Don't record

This option is used to exit from this menu without recording.

2) Recording by Timer

[] : Press MENU key > Select Timer]

You can manage recording process using *Timer List* menu. Press **MENU** key and select *Timer* on the menu.



In this menu, COLOR keys are assigned for each different function.

- RED (Delete)

This option is used to delete a timer.

- GREEN (Add)

This option is used to add a timer.

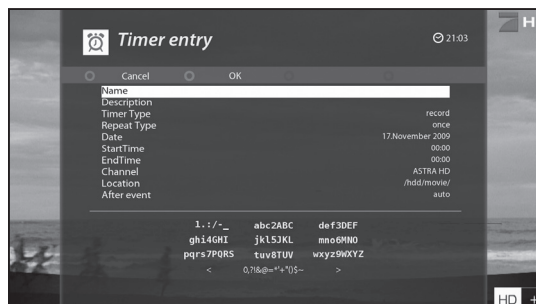

- YELLOW (Disable)

This option is used to disable the timer and X mark will appear.

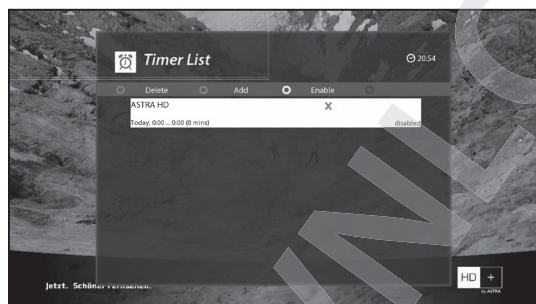

NOTE : if you want to enable the disabled timer, press **YELLOW** key again.

- BLUE (Cleanup)

This option is used to remove those finished timers from the *Timer List*.



NOTE : Make sure that the HDD on your Vu+ has enough free space available for recording. If the free space on the HDD is not sufficient, recording might stop before the defined end time.

- Stop Recording [i] : Press REC [stop] key > Select "Stop Recording"

If you want to stop recording, press REC [stop] key again while recording is running. Select *Stop Recording*.

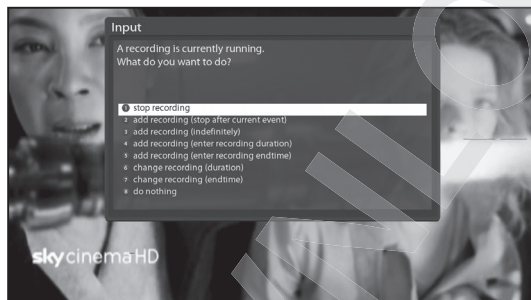

11. Recording Play

[i] : Press Recording List (PVR) key]

You can view recorded files on the *Recorded files* menu. Press **Recording List** (PVR) key to activate this menu.

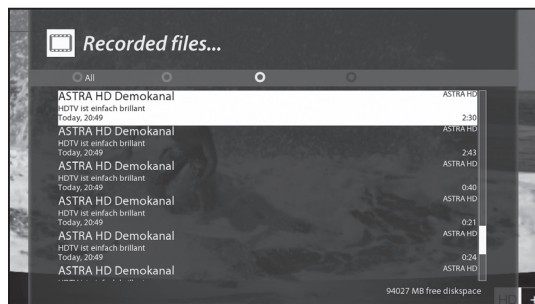

Select the file that you want to play. It will instantly replay the file and display the recording info bar.



This info bar gives you the following information of the recording.

- 1) Title of the recording
- 2) Total duration of recording
- 3) Remaining time
- 4) Progressive bar
- 5) Elapsed time

12. Managing Recording Files

[**i**] : Press Recording List **PVR** key > Press MENU **MENU** key]

If you want to delete a recording file, press **MENU** key while *Recorded files* menu is on.



Select "**delete**" and confirm **OK** to delete.

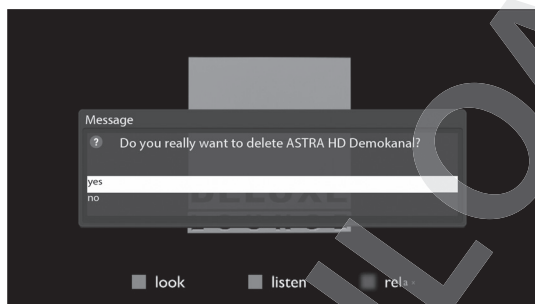

Other than "**delete**", in this menu, you have options in sorting and listing of the recording files.

- Sort by date
- List style default
- List style compact with description
- List style compact
- List style single line
- Hide extended description.

13. Media Player

[**i**] : MENU **MENU** > Media Player]

Vu+ is truly a multimedia receiver capable of playing media contents. Using Media Player, you can enjoy Music, Photo and Video contents stored on the internal HDD and/or an USB memory stick plugged into Vu+.

If you play *Media Player*, the following player will appear.

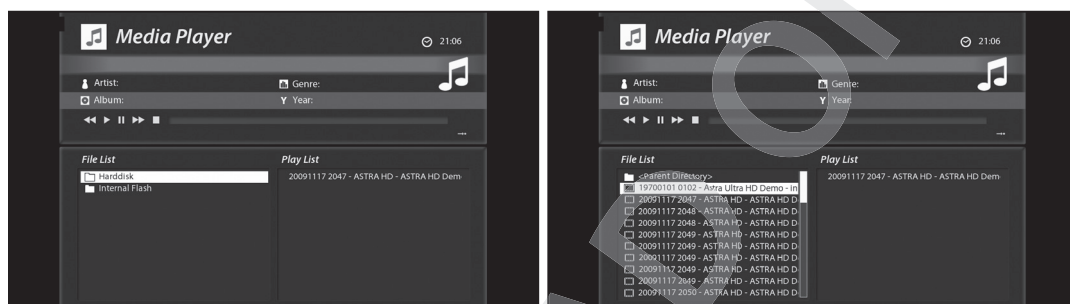

- 1) Go into any directory of the HDD or plugged USB.
- 2) Select a file in the *File List* to play and press OK key. The selected file will be displayed in the *PlayList*.
 - * Supported formats are mainly JPG, MP3, AVI, etc.
- 3) In the same way, you can play the recording files stored on the HDD.
- 4) To move between *File List* and *Play List*
 - Press CH- key to go into *Play List*
 - Press CH+ key to go into *File List*
- 5) To call up *Media Player* window
 - Press Play(**▶**), or Pause(**⏸**) or Stop(**■**) key.
- 6) To play
 - Select a file in the *Play List* and press OK key.

14. Plug-ins

[i] : MENU <MENU> > Plugins]

Zero4K is integrated with 10/100Mbps Ethernet with RJ 45 connector. You are recommended to use this network capability of Vu+ to fully enjoy the system. If your Vu+'s network connection is established, you can directly download plug-ins from a designated website of Vu+.

- 1) Press **MENU** key and select *Plugins* menu to active *Plugin browser*.
- 2) Press **GREEN** key to download a list of plug-ins available.
- 3) Once the download is done, a list of plug-ins will be displayed.
- 4) Select a plug-in to download.
- 5) You can check if the download is done properly on the Plugin browser

From this site, you can check available plug-ins to download as below.



15. Sleep Timer

[i] : MENU **MENU** > Idle Server Mode/ Restart > Sleep Timer]

You can set a specific time when your Vu+ goes into Idle Server Mode or Standby mode, using this menu. Three COLOR keys are used to set up this sleep timer.

1) RED

This option is used to enable or disable *Sleep Timer*.

2) GREEN

This option is used to choose between *Idle Server Mode* and *Standby mode*.

3) YELLOW

This option is used to choose whether to be asked of confirmation before system shutdown.

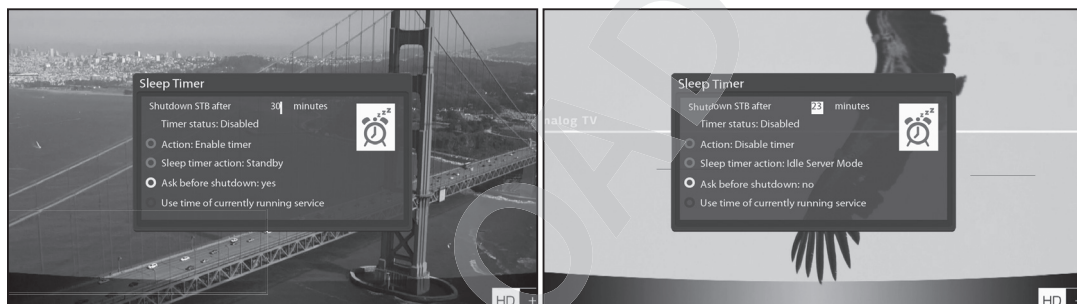

IV. System Configuration

Vu+ is a very sophisticated device designed to allow users a variety of system setting options. You can fine-tune your Vu+ to be your OWN system to fit your taste. This chapter will guide you through the entire menu of system configuration.

Prior to System Configuration, please take a notice on the menu structure of Vu+ first.

1. Main Menu

[] : Press MENU  key]

The main menu of Vu+ consists of the following sub menus.

1) Media player

Activate Media player of Vu+. For more information, please refer to Media Player section.

2) Timer

Activate Media player of Vu+. For more information, please refer to Media Player section.

3) Information

Has two sub menus for *Service / About*. *Service* menu provides the detailed information of the current channel. *About* menu provides the detailed information of the H/W and S/W system of your Vu+.

4) Plugins

Activates Plugin browser of Vu+. Using this browser, you can log onto the designated website and you can download a variety of new plug-ins.

5) Setup

Provides all of the system settings.

6) Standby / Restart

Provides options for power on/off and sleep timer.



2. System Setup

[**i**] : Press MENU **MENU** key > Select Setup]

The Setup menu consists of the following sub-menus.



- Service Searching
- System
- Common Interface
- Parental Control
- Factory reset

1) Service Searching

[**i**] : Press MENU **MENU** key > Setup > Service Searching]

Here you set up the tuners of your Vu+ and run channel scanning automatically or manually.

A. Tuner Configuration

[**i**] : MENU **MENU** key > Setup > Service Searching > Tuner Configuration]

If you run the First Time Installation process, the Tuner A/B is already configured. You can check the information of Tuner A/B and which satellites are scanned, as follows.



B. Loading Default Service Lists

[**i**] : MENU **MENU** > Setup > Service Searching > Default Service List]

In case there are service lists available for certain satellites, for example, Astra or Hotbird, you can install the lists in the channel list of your Vu+.

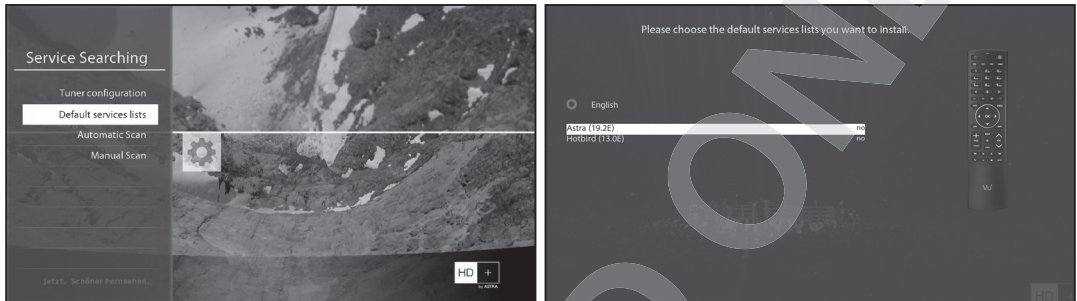

If default service lists are not available, you can run the service scan automatically or manually to add TV and radio channels into the channel list of your Vu+.

C. Automatic Scan of Services

[**i**] : MENU **MENU** > Setup > Service Searching > Automatic Scan]

The easiest way to scan services is to use *Automatic Scan*. In the *Automatic Scan* menu, there are two options to choose from as below.



- **Clear Before Scan**

YES is used when you want to delete the existing channel list before you start the automatic scan.

If you want to keep the existing list, select **NO**.

Press **OK** key to activate the automatic scan. This will take some minutes. As the scan proceeds, you will see the progressive bar and the newly found services underneath.



D. Manual Scan of Services

[**i**] : MENU **MENU** > Setup > Service Searching > Manual Scan]

If you know well enough to configure each exact setting required for manual search of services, you can do manual scan as well. There are many parameter values that you need to decide as below.

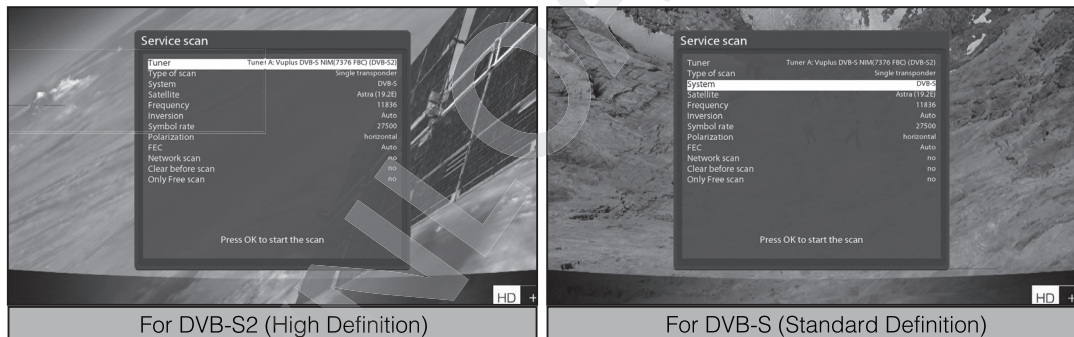

Amongst other things, the below parameters are what you need to decide prior to manual scan.

A) Tuner

You need to decide which tuner you want to use for manual scan.

B) System

Here you have two options between DVB-S (SD) and DVB-S2 (HD), if DVB-S2 tuner is mounted.

C) Frequency

You need to enter the exact frequency of the transponder that you want to scan.

D) Symbol Rate

You need to enter the exact symbol rate of the transponder that you want to scan.

E) Polarity

Here, you have options for Horizontal, Vertical, Circular Left and Circular Right. You need to know the polarity of the transponder that you want to scan.

F) FEC (Forward Error Correction)

You need to enter the exact FEC value of the transponder that you want to scan.

G) Modulation

Here you have two options for QPSK (SD) and 8PSK (HD).

H) Network Scan

Here you have two options for **YES** and **NO**. **NO** is used to scan the transponder (TP) based on the data that your Vu+ currently has. **YES** is used to scan the TP not just based on the existing TP data but also using new TP data, if there is TP data newly transported from the TP. Naturally, **YES** option takes longer while it may result in a better scan result.

I) Clear Before Scan

YES is used when you want to delete the existing channel list before you start the automatic scan. If you want to keep the existing list, select **NO**.

J) Only Free Scan

Here you have two options for **YES** and **NO**. If you want to scan only Free To Air channels without any encryption, select **YES**. Otherwise, select **NO** to scan all FTA and CAS channels.

Press **OK** key to activate the manual scan. This will take some minutes. As the scan proceeds, you will see the progressive bar and the newly found services underneath.



E. Tuner Configuration (for DVB-C)

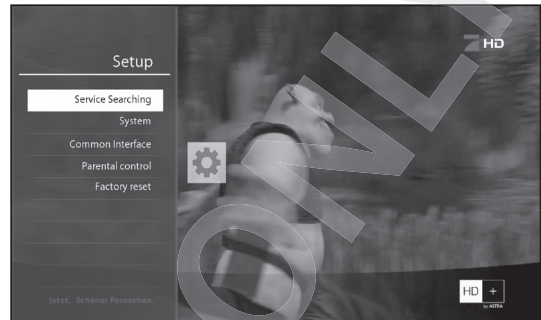
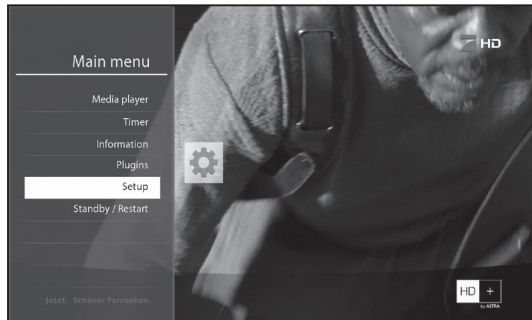

A) Go to Setup => Service Searching => Tuner Configuration



B) Press OK key to activate Tuner A window.

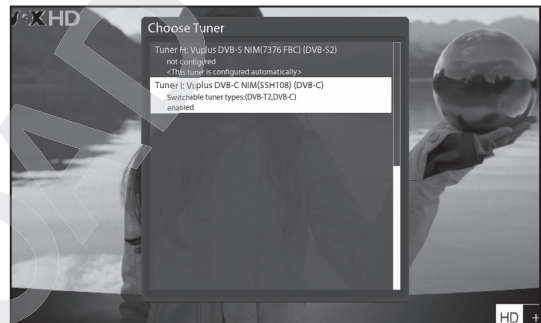

C) Press OK key again Reception Setting window.

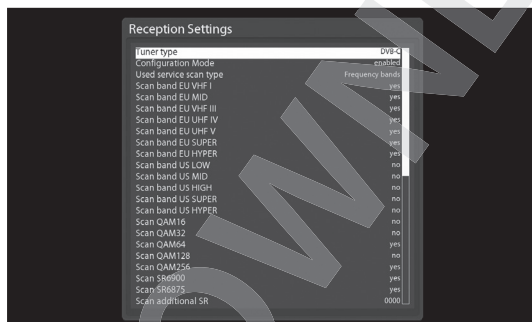

D) You can decide whether to scan each of the various scan band in the list.

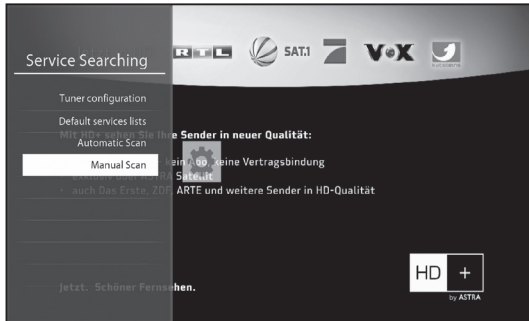

E) Go to Setup => Service Searching
For the channel scan, you can select between Automatic Scan and Manual Scan.

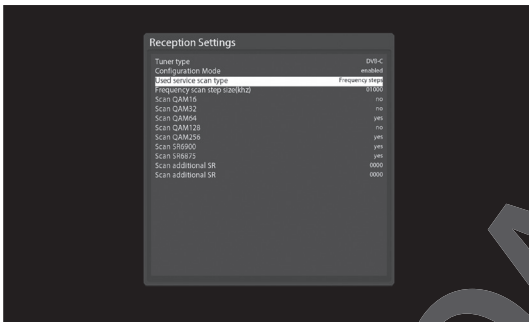

F) Press OK key to call up Service Scan window.



G) Press OK key to begin the channel scan.
Once the scan is done, the scan results will be displayed.

2) System Configuration

[**i**] : Press MENU **MENU** key > Setup > System]

Here you can find most of the necessary settings that you might need to optimize your Vu+ in the way you like it. Please read the followings carefully.

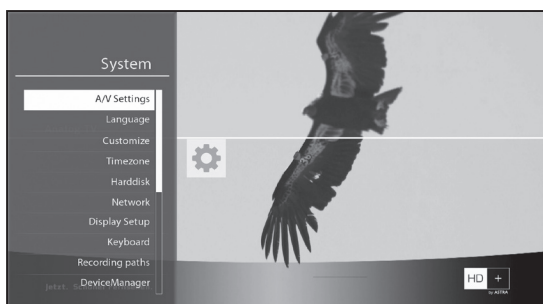

A. A/V Settings

[**i**] : MENU **MENU** > Setup > System > A/V Settings]

Here you will find options necessary to set up the audio and video configuration of your Vu+.

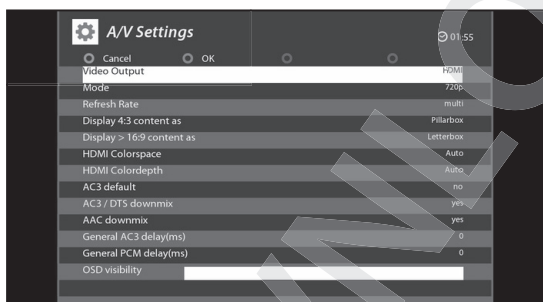

NOTE : RED is for cancel and GREEN is OK. OK key of RCU is not working in this mode.

Amongst the parameters given in this menu, the following ones are generally what you need to decide for the audio and video.

A) Video output

Here you need to decide which video output you want to use between your TV and Vu+. The available options are as below.

- HDMI

B) Mode

You need to decide which resolution to use according to the video output above and your TV amongst the following options.

	HDMI
Resolution	2160p
	1080p
	1080i
	720p
	576p
	576i
	480p
	480i

B. Language Selection

[i] : MENU [MENU] > Setup > System > Language]

A variety of languages are available for the OSD(On-Screen Display) of Vu+.

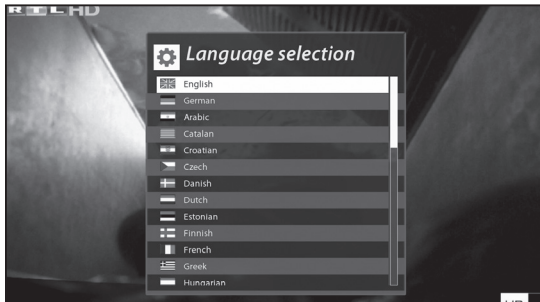

C. Customization

[i] : MENU [MENU] > Setup > System > Customize]

In this menu you will find various customization options and this menu can be displayed in three different formats: *Simple*, *Intermediate*, and *Expert*.

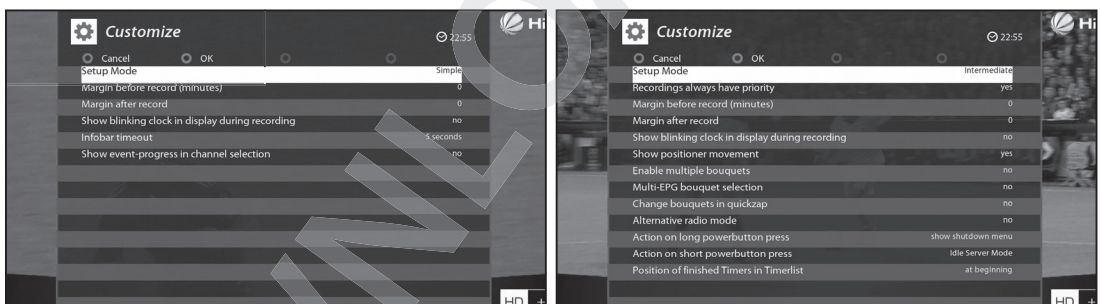

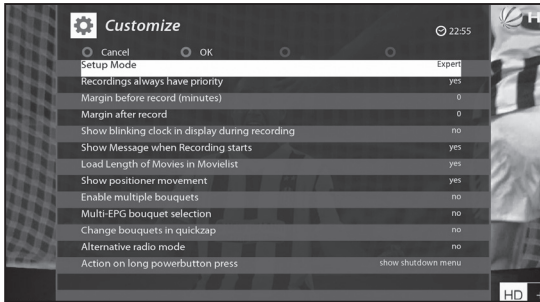

NOTE : RED is for cancel and GREEN is OK. OK key of RCU is not working in this mode.

Amongst the options given in this menu, the following ones are generally what you may need to know.

A) Recording always have priority

YES option is used to set the recording to have a priority over any existing timer. If there occurs a conflict between a timer and a recording in progress, the recording has a priority over the timer. If you set this option at **NO**, you will be asked whether to switch to the service to record or not.

B) Margin before record (minutes)

If you enter a number here, for example, 5, the recording will begin 5 minutes before the defined time. If it is "0", it means that the recording starts exactly at the defined time. This option comes in handy, just in case that a program starts earlier than the original schedule.

C) Margin after record

If you enter a number here, for example, 5, the recording will stop 5 minutes after the defined time. If it is "0", it means that the recording stops exactly at the defined time. This option comes in handy, just in case that a program ends later than the original schedule.

D) Show Message when Recording starts

If you set this option at **YES**, a message saying that a recording has started appears as below.



E) Enable multiple bouquets

If you set this option at **YES**, it will enable multiple bouquets.

D. Selecting Time Zone

[**?**] : MENU **MENU** > Setup > System > Timezone]

You can set your time zone in this menu.

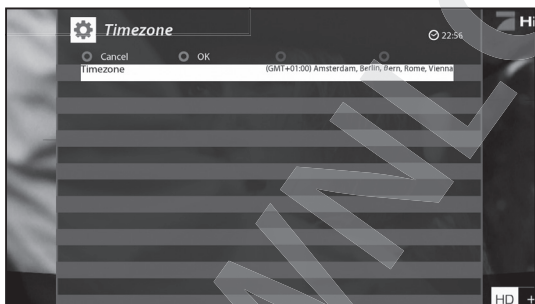

Using **LEFT/RIGHT** key, you can find a time zone that you want to use for your Vu+. After selecting a time zone, press **GREEN** key to confirm and save the changed setting.

E. Hard Disk Set Up

[**i**] : MENU **MENU** > Setup > System > Harddisk > Harddisk setup]

You can set the duration of time after which HDD is to be put into Idle Server Mode.



Here, you can choose from

- No Idle Server Mode
- 10 or 30 seconds
- 1, 2, 5, 10, 20, 30 minutes
- 1, 2, 4 hours.

Once you set this option, press **GREEN** key to confirm the change.

F. Network Setup

[**i**] : MENU **MENU** > Setup > System > Network]

Vu+ is integrated with 10/100Mbps Ethernet with RJ 45 connector. You are recommended to use this network capability of Vu+ to fully enjoy the system. You can set up the network settings through this *Network Configuration* menu.

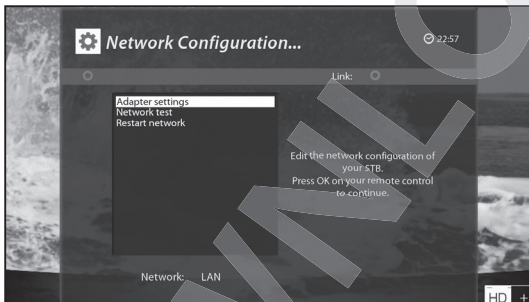

In the *Network Configuration* menu, you will see five sub menus as follows:

A) Adapter settings

Through this menu, you can set the basic Ethernet configuration.

- **User Interface**

YES is used to activate the Ethernet. If you set this option at **NO**, the Ethernet will not work.

- **Use DHCP**

YES is used to use *DHCP (Dynamic Host Configuration Protocol)*. If you set this option at **YES**, it will automatically detect the correct IP address. **NO** is used when you want to use a certain fixed IP address. In this case, you need to enter correct addresses in each field.

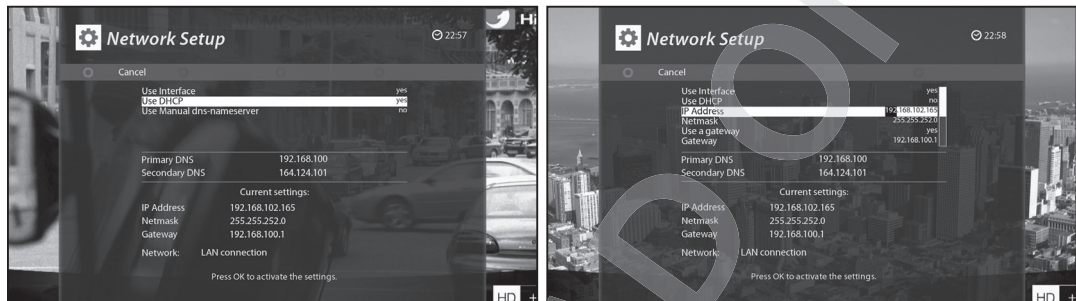

- **Use Primary Domain Name Server**

This option is required when you select No for DHCP. You need to type the IP Address for using the Primary Domain Name Server (DNS).



B) Network test

When you are not sure whether the network configuration has been done correctly or not, you can run this test.

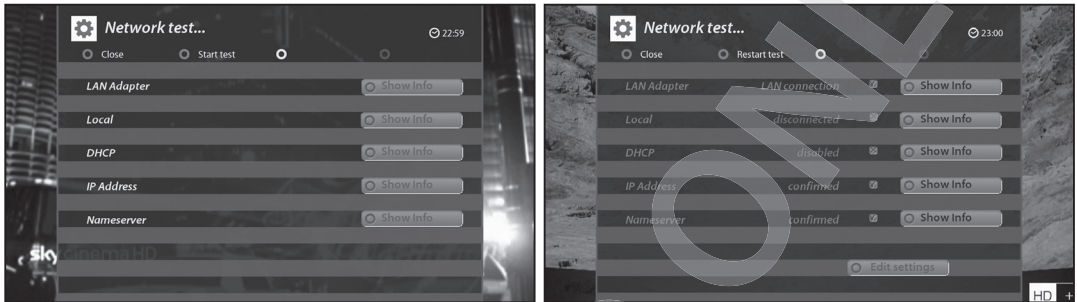

C) Restart Network

This option is used when you want to reboot the Ethernet of your Vu+.

G. Skin Change

[?] : MENU (MENU) > Setup > System > Skin]

Vu+ is a Linux based set top box and there are a lot of Skins available for Linux set top box. Using this menu, you can use a different Skin other than the default one.

NOTE : It takes some minutes since the change of Skin requires a complete system shutdown. Please wait patiently until the system reboots with a newly selected Skin.

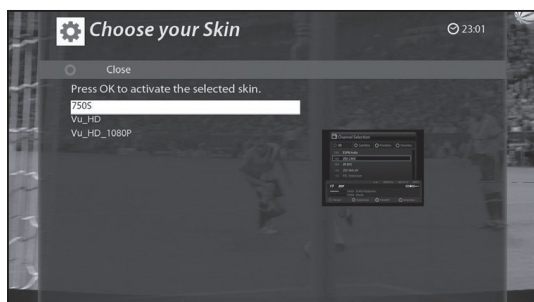

3) Checking CAM

[?] : MENU (MENU) > Setup > Common Interface]

To be able to watch CAS channels, you need to have a proper CAM and a Smartcard. Vu+ is integrated with two Common Interface slots. If you have two CAM modules and keep them inserted in your Vu+, it will reduce the trouble of changing CAM.

If you have inserted one or two CAMs, you can check the information of the inserted CAMs, through this menu as below:



4) Parental Control

[**i**] : MENU **MENU** > Setup > Parental Control]

If you want to prevent certain channels from being accessed by others, you can do so using this menu.

A. Go to Parental Control menu by pressing MENU > Setup > Parental Control.

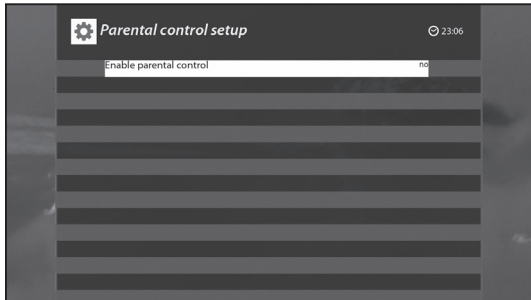

B. Set the parental control option at **YES** using LEFT/RIGHT key. The menu will change as below.

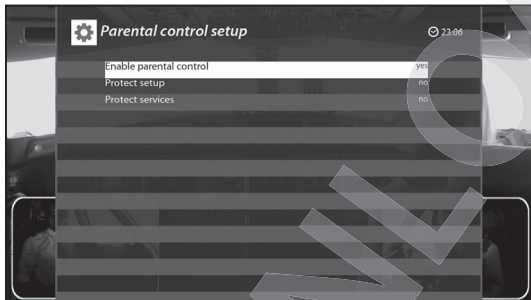



- **Protect setup**

If you set this option at **YES**, you will be asked to enter PIN code when you enter this **Parental setup** menu.

- **Change setup pin**

If you want to change the existing PIN code for Parental setup, you can do so using this menu.

You need to enter a new PIN code twice.

- **Protect services**

You need to set this option at **YES**, if you want to lock certain channels with PIN code.

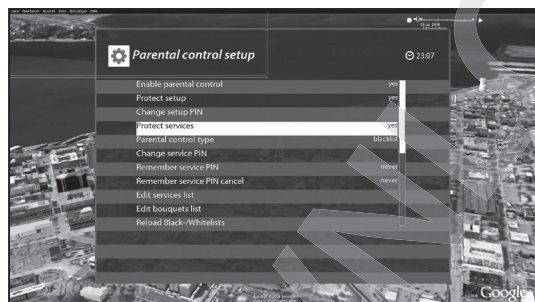

- **Parental control type**

This option will be activated only when you set **Protect services** at **YES**. Here there are two options:

- **White list** : This option is used to block all channels except those channels in the parental control list.
- **Black list** : This option is used to block only those channels included in the parental control list.

- **Change service pin**

Here you can define a PIN code required to change services to be included in the parental control list.

NOTE: PIN code here is used for Change service and thus you are recommended to use a PIN code different from that used for **Protect services**.

▪ Edit service list

Here you can add services that you want to lock with PIN code. Services will be arranged in the alphabetical order and you can select an alphabet to enter into the list where you can find the channel that you want to lock.



Here, T is selected and TV5 is locked in the list as an example.

Next time when you or anyone else want to tune into this service, the menu asking for PIN code will appear instantly as below.

NOTE : It is very important not to lose this PIN code.

5) Factory Reset

[**i**] : MENU **MENU** > Setup > Factory Reset]

If you want to erase all installed service list as well as all configurations, run the **Factory Reset** process. Select **YES** in the below menu to run the factory reset.

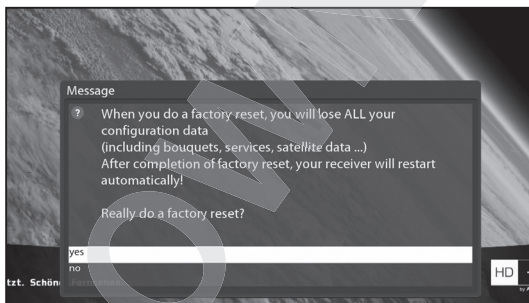

Upon the completion of factory reset process, your Vu+ will reboot automatically and start the **First Time Installation** process.

NOTE : If you do this factory reset, all of your configuration data including bouquets, service lists, satellite parameters, and so on will be erased.

6) Checking H/W & S/W Information

[**i**] : MENU **MENU** > Information]

If you want to check the H/W or S/W system of your Vu+, this is the menu that you need to use. Also, here you can check very detailed information of a specific service.

A. Service Information

[**i**] : MENU **MENU** > Information > Service]

In this menu, you can see all the parameter data of the current channel. The service information is well arranged in four sections as below:



A) Service info



B) PIDs



C) Multiplex



D) Tuner Status

B. System Information

[i] : MENU [MENU] > Information > About

This menu is for you to check the current system of your Vu+. You can see the following information:



- A) S/W version
- B) Detected NIMs
- C) Detected HDD

7) Zero 4K to combine PVR KIT

How do you use a PVR KIT?

- Just follow these instructions



A) Open the PVR KIT.



B) Insert 2.5" HDD.

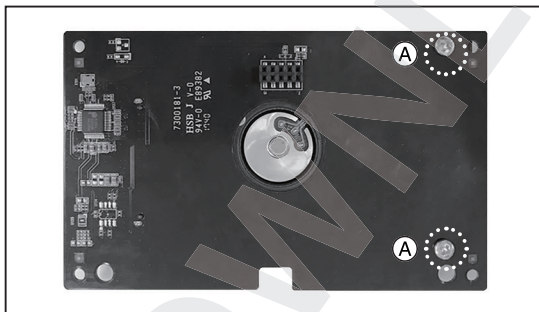

C) Tighten the screw A point on the back of the PCB.

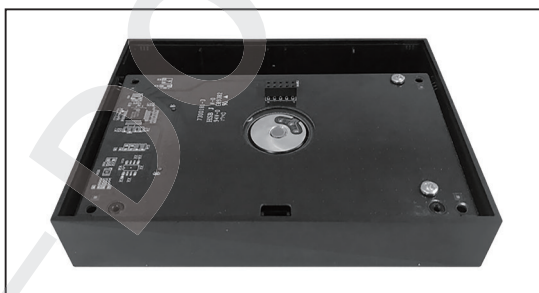

D) Put the PCB Combined with the HDD into the PVR KIT.

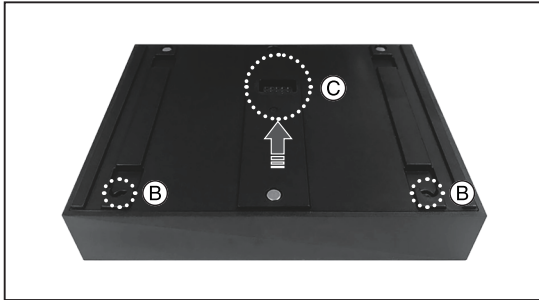

E) Place the docking station up. Tighten the screw B point.

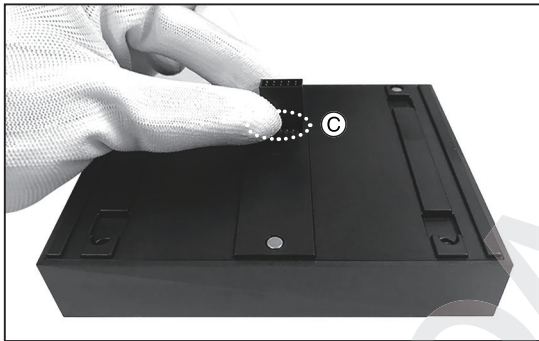

F) Combine the connector into the C point located on the PVR KIT docking station.



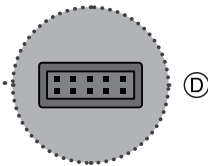

G) Combine the connector into the D point located on the bottom of the Zero 4K.





8) Remote Control Unit (RCU) Set-up

A. User Guide of Vu+ RCU



A) RCU keys for TV

- a. Keys for TV only: **Power** (), **AV** () key
- b. Keys switchable between TV and STB: **Volume + /-** and **MUTE** () key
- c. All the other keys are for STB only

B) Volume Punch (Volume +/-, Mute key setup)

- a. Default Volume and Mute Control : STB
- b. Setup **Volume + /-** and **MUTE** () key to STB mode
 - a) Press **TV Power + OK** keys at the same time for 3 seconds or press until RED LED is on.
 - b) Press **STB Power** key.
 - c) RED LED blinks 2 times, then off.
- c. Setup **Volume +/-** and **MUTE** () key to TV mode
 - a) Press **TV Power + OK** keys at the same time for 3 seconds or press until RED LED is on.
 - b) Press **TV Power** key.
 - c) RED LED blinks 2 times, then off.

C) TV Setup

- a. 5-Digit Code Setting
 - a) Turn on the TV.
 - b) Press **TV Power + OK** keys at the same time for 3 seconds or press until RED LED is on.
 - c) Press 5-digit Code for TV vendor : LED will blink 1 time when you press 5-digit code and if the digit code set up properly, the signal for TV power-on will be out once.
 - d) Once RCU recognize the TV code properly, RED LED blinks once and then it will be on. : If you press **OK** key, LED blinks 2 times and the code will be saved.
 - e) If the code is not valid one, RCU does not send Power IR code. And RED LED will be off for 0.5 seconds and it turns on again. You can press other code or press **OK** key for finishing set-up 5-digit mode.
 - f) After set-up TV vendor, Volume Punch(**Volume +/-, Mute** keys) will be automatically set up to TV mode.
- b. Auto Search Setting
 - a) Turn on the TV.
 - b) Press **TV Power + OK** at the same time for 3 seconds or press until RED LED is on.
 - c) Press **CH up** or **CH down** key. LED blinks once when you press **CH up** or **CH down** key and the signal for TV power will be out at the same time with pressing **CH up** or **CH down**.
 - d) When you press **OK** key, LED blinks 2 times and then it will be off.
 - e) After set-up TV vendor, Volume Punch(**Volume +/-, Mute** keys) will be automatically set up to TV mode.
- c. You cannot use with IR code for **Power** (), **AV** () keys unless the user setup TV.



D) STB Setup (System code change)

- a. The default system code is Mode 2.
- b. 5-Digit Code Setting
 - a) Press **STB Power** + **OK** keys at the same time for 3 seconds or press until RED LED is on.
 - b) RED LED will be still on even you release **STB Power** + **OK** keys.
 - c) Press 5-Digit Code.(Default : 00002)

00001	Mode 1
00002	Mode 2
00003	Mode 3
00004	Mode 4

- d) LED will blink 1 time then it is on when you press 5-digit code properly and if you press **OK** keys LED blinks 2 time and all the setup will be saved automatically.
- e) If the code is not valid one, RED LED will be off for 0.5 seconds and it turns on again. You can press other code or press **OK** key for finishing set-up 5-Digit mode.

E) Factory Reset

- a. Press  +  keys at the same time for 5 seconds.
- b. The RED LED will blink 3 time after 5 seconds and all IR setup data including RCU pairing will be cleared.

F) Low Battery

- a. If the battery level is low, RCU will be working as "Low Battery mode". The RED LED will blink 5 times when you press any keys on RCU and you need to change the batteries to new one.
- b. All the data you setup of IR will not be cleared even if the batteries are removed.

B. TV Code List
Brand ID for Device TV:

ACER	10746, 10640	ARISTONA	10230, 10122, 10119, 10111, 10109
ADL	10299	ASA	10234, 10105, 10102, 10087
ADMIRAL	10204, 10058	ASBERG	10267, 10185
ADYSON	10219	ASORA	10171
AEG	10759, 10673, 10652, 10643, 10642, 10572, 10533, 10532, 10319, 10286, 10282, 10263, 10249, 10123, 10109, 10031	ASTROSOUND	10108
AG	10282	ATLANTIC	10197, 10089
AGFAPHOTO	10655	AUDIOSONIC	10269, 10267, 10263, 10250, 10218, 10185, 10171, 10164, 10110, 10108, 10090, 10085, 10074
AHB TVISIONS	10131	AURORA	10219, 10171, 10170
AKAI	10679, 10648, 10636, 10517, 10287, 10280, 10279, 10275, 10251, 10250, 10249, 10155, 10108, 10106, 10104, 10103, 10097, 10093, 10074, 10036, 10027	AUTOVOX	10282, 10249, 10197, 10163, 10123
AKITA	10085	AWA	10108
AKURA	10624, 10542, 10541, 10430, 10429, 10428, 10174, 10171, 10108, 10086, 10074, 10064	AWATRON	10171
ALBA	10713, 10307, 10264, 10250, 10249, 10202, 10175, 10172, 10127, 10108, 10074, 10069, 10064, 10060	AXXION	10726, 10724, 10698, 10681, 10628, 10546
ALIEN	10264	BAIER	10751
ALLSTAR	10251, 10108	BAIRD	10750, 10733, 10578, 10524, 10188, 10032
ALTUS	10250	BANG & OLUFSEN	10204
AMSTRAD	10286, 10249, 100171, 100123, 10074, 10025	BASIC LINE	10277, 10264, 10249, 10170, 10120, 10108, 10033
ANAM	10285	BAUR	10266, 10256, 10251, 10233, 10217, 10216, 10212, 10211, 10171, 10143, 10131, 10111, 10108, 10097, 10096, 10092, 10074, 10045, 10042, 10036
ANDERSSON	10123	BEKO	10691, 10690, 10510, 10296, 10263, 10255, 10250, 10225, 10195, 10130, 10117, 10108, 10090, 10086, 10085, 10049
ANITECH	10277, 10267, 10251, 10219, 10185, 10108	BELSON	10741, 10686, 10685, 10580
ANSONIC	10786, 10732, 10108	BELSTAR	10249, 10116, 10108
ANTECNO	10064	BEST	10282
AOC	10016	BESTAR	10249, 10108, 10086
ARCELIK	10296, 10086, 10085	BLACK DIAMOND	10249, 10120
ARDEM	10250, 10085	BLACK PANTHER	10185
ARENA	10250, 10127		
ARGOS	10250		

BLAUPUNKT	10723, 10599, 10256, 10253, 10119, 10099, 10097, 10096, 10092, 10091	CONRAC	10225		
BLUSENS	10787, 10654, 10611	CONTEC	10277, 10171		
BLUE SKY	10286, 10282, 10273, 10264, 10250, 10249, 10172, 10109	CONTI	10263, 10250		
BLUESTAR	10108, 10063	CONTINENTAL	10172		
BOMANN	10282	CONTINENTAL EDISON	10193, 10172		
BONDSTEC	10163	COSMOS	10108		
BRANDT	10270, 10195, 10193	CROSLEY	10267, 10204, 10165		
BRIONVEGA	10204	CROWN	10764, 10286, 10282, 10274, 10267, 10264, 10263, 10255, 10250, 10249, 10185, 10171, 10108, 10090, 10086, 10085, 10063		
BROKSONIC	10285		CS-ELECTRONICS	10163, 10064	
BRUNS	10204		CURTIS	10260, 10111	
BUSH	10774, 10766, 10725, 10568, 10314, 10303, 10287, 10286, 10283, 10264, 10250, 10249, 10232, 10202, 10123, 10121, 10115, 10108, 10074, 10069, 10063, 10031		D-VISION	10108	
	CAMPER	10085	DAEWOO	10720, 10598, 10540, 10519, 10431, 10269, 10170, 10127, 10120, 10108	
	CELLO	10536, 10434, 10318, 10315, 10312, 10311, 10310, 10301		DANSAI	10219
		CENTURY		10204, 10165	DANTAX
	CGE	10267, 10260, 10165	DAYTEK	10194	
	CGM	10264, 10108, 10086, 10085	DECCA	10190, 10189, 10184, 10128, 10108, 10069, 10066, 10063	
	CHANGHONG	10717		DELTON	10249
	CIE	10171, 10170, 10166, 10108, 10064, 10025	DENVER	10703, 10638, 10625, 10596, 10282, 10171, 10074	
	CINERAL	10272		DESMET	10108
	CINEX	10294, 10031	DGM	10669, 10426	
CLARIVOX	10258, 10232	DIBOSS	10621		
CLATRONIC	10742, 10296, 10294, 10286, 10282, 10267, 10260, 10255, 10250, 10249, 10218, 10185, 10171, 10165, 10164, 10110, 10108, 10074, 10064	DIGIFUSION	10225		
	CMX	10770, 10765, 10763, 10591, 10589	DIGINUM	10031	
		CONDOR	10267, 10260, 10255, 10229, 10171, 10109, 10108	DIGITREX	10586
	CONIC		10219	DIGIX	10187
			DISNEY	10062	
		DMTECH	10778, 10529, 10320, 10308, 10304, 10286, 10249		
			DOMUS	10108	
		DUAL	10293, 10286, 10279, 10250, 10249, 10248, 10233, 10127, 10123, 10108		

DUMONT	10267, 10234, 10204, 10185, 10110, 10109, 10105, 10102, 10087
DURABRAND	10282, 10249
DYON	10754, 10666, 10664, 10618, 10610
E-MAX	10194
ECG	10751, 10250, 10117, 10069
EDISON	10172
EDISON MINERVA	10172
ELBE	10273, 10229, 10209, 10185, 10120, 10108, 10074, 10058
ELBIT	10248, 10108
ELCIT	10164
ELECTRIC	10109
ELECTRIC CO	10250
ELEKTA	10171, 10108
ELEKTRONIKA	10274, 10116, 10108, 10086
ELEMIS	10294, 10282, 10074, 10031
ELIN	10108, 10087
ELITE	10467, 10064
ELMAN	10185
ELTA	10171, 10108
EMERSON	10204, 10108, 10086
ESC	10108
EUROLINE	10286
EUROPHON	10185, 10033
EUROSKY	10249
EVELUX	10116, 10108
EXPERT (I)	10089
EXQUISIT	10110, 10108
FENNER	10251, 10249, 10171, 10108
FERGUSON	10594, 10549, 10548, 10544, 10507, 10270, 10195, 10078, 10032
FIDELIS	10108
FINLANDIA	10195, 10189, 10105, 10104, 10033

FINLUX	10290, 10279, 10276, 10275, 10251, 10234, 10229, 10225, 10189, 10128, 10116, 10108, 10107, 10105, 10104, 10103, 10102, 10087, 10074, 10069, 10066, 10031
FIRST-LINE	10294, 10273, 10264, 10251, 10249, 10108
FISHER	10233, 10221, 10086, 10052, 10051
FLINT	10273
FORCE	10286, 10194, 10123
FORMENTI	10229, 10110, 10109, 10108
FRABA	10248, 10108
FRONTECH	10220, 10171, 10166
FUJITSU GENERAL	10554, 10197, 10088
FUNAI	10755, 10629, 10617, 10293, 10286, 10264, 10249
F&U	10555
GALAXIS	10260, 10255, 10185, 10108
GALAXY	10255
GALERIA	10171
GBC	10269, 10267, 10171
GEC	10189
GELOSO	10171, 10164, 10064
GENERAL	10171
GENERAL TECHNIC	10171
GERICOM	10300, 10225, 10187
GOLDFUNK	10264, 10249
GOLDHAND	10171
GOLDLINE	10273
GOLDSTAR	10288, 10268, 10263, 10250, 10237, 10219, 10191, 10171, 10166, 10163, 10110, 10108, 10090, 10074, 10038
GOODING	10172

GOODMANS	10605, 10543, 10321, 10316, 10306, 10305, 10287, 10286, 10285, 10275, 10270, 10269, 10268, 10264, 10251, 10250, 10249, 10225, 10224, 10195, 10194, 10187, 10176, 10171, 10170, 10123, 10120, 10115, 10110, 10109, 10108, 10103, 10074, 10068, 10064, 10063, 10031	HAIER	10774, 10733, 10313
GORENJE	10286, 10274, 10249, 10116, 10108, 10090, 10086	HANNSPREE	10706, 10602
GPM	10064	HANSEATIC	10308, 10296, 10277, 10269, 10251, 10250, 10248, 10229, 10225, 10220, 10191, 10171, 10127, 10120, 10110, 10108, 10100, 10085, 10060
GRADIENTE	10038	HARWA	10297
GRAETZ	10296, 10263, 10250, 10249, 10172, 10108	HB	10282
GRAN PRIX	10734, 10696, 10294, 10127, 10031	HB INGELEN	10172
GRANADA	10270, 10251, 10224, 10218, 10208, 10195, 10189, 10184, 10167, 10128, 10119, 10111, 10109, 10108, 10105, 10104, 10103, 10090, 10086, 10085, 10082, 10081, 10079, 10078, 10075, 10054, 10051, 10049, 10045, 10043, 10042, 10041, 10039, 10036, 10033, 10032, 10029, 10027, 10022	HCM	10277, 10171, 10108
GRANDIN	10273, 10069	HINARI	10224, 10171, 10108, 10064
GREAT WALL	10074	HISAWA	10273
GRUNDIG	10790, 10789, 10777, 10691, 10690, 10552, 10527, 10510, 10287, 10253, 10250, 10232, 10210, 10202, 10194, 10187, 10172, 10155, 10130, 10117, 10116, 10101, 10100, 10097, 10096, 10095, 10094, 10093, 10092, 10091, 10073, 10069, 10063, 10031	HISENSE	10772, 10753, 10752, 10551, 10302
GRUNKEL	10785, 10732, 10545	HIT	10204
H&E	10282	HITACHI	10744, 10659, 10581, 10515, 10422, 10295, 10286, 10279, 10276, 10269, 10266, 10249, 10219, 10193, 10189, 10186, 10143, 10128, 10127, 10123, 10120, 10119, 10108, 10104, 10057, 10056, 10055, 10054, 10053, 10041, 10040, 10039, 10035, 10030, 10029, 10028, 10024, 10023, 10022
		HITSU	10273
		HL	10251, 10195, 10108
		HOHER	10250, 10249, 10123, 10117, 10069
		HOSHAI	10264
		HUMAX	10776, 10577, 10576
		HYPER	10171, 10163
		HYPSON	10293, 10264, 10263, 10250, 10249, 10118, 10108, 10074, 10069, 10063
		HYUNDAI	10317, 10235, 10180, 10155, 10152
		ICE	10171, 10108, 10064
		IDEAL	10264
		IMPERIAL	10267, 10260, 10255, 10229, 10165, 10110, 10109, 10108

INGELEN	10279, 10273
INGERSOLL	10171
INNO HIT	10249, 10237, 10189, 10127
INTERCORD	10233
INTERFUNK	10265, 10255, 10251, 10165, 10108, 10067
INTERVISION	10191, 10166, 10108, 10086, 10085
IPOSTAR	10171
IRRADIO	10264, 10249, 10237, 10163, 10108, 10074
IRT	10446, 10440, 10439, 10437
ISKRA	10085
ITL	10171
ITS	10171, 10064
ITT	10784, 10268, 10250, 10117, 10032, 10031
I-JOY	10667
JAY-TECH	10761
JETPOINT	10268
JMB	10063
JOCEL	10283, 10282, 10074, 10069
JTC	10761
JVC	10604, 10588, 10575, 10278, 10169, 10120
KAISUI	10280, 10273, 10249, 10127
KAMACROWN	10064
KAPSCH	10197, 10089
KARCHER	10289, 10282, 10274, 10273, 10250, 10185, 10117, 10109, 10108, 10074, 10031
KATHREIN	10187
KENDO	10296, 10273, 10270, 10249, 10229, 10127, 10108, 10060
KENNEDY	10197
KENNEX	10264, 10249, 10108
KEYMAT	10235, 10207
KIOTO	10442, 10441, 10439, 10438, 10436
KITON	10293, 10264, 10249
KNEISSEL	10273, 10264, 10249, 10229, 10108, 10058
KOERTING	10274, 10204, 10086

KOGAN	10758
KUBA ELECTRONIC	10233
LAZER	10074
LECSON	10116
LENCO	10721, 10689, 10684, 10682, 10628, 10593, 10546, 10249, 10170, 10110, 10108
LENOIR	10264, 10249
LEVEL	10612, 10425
LG	10708, 10707, 10634, 10592, 10553, 10512, 10511, 10509, 10504, 10503, 10502, 10501, 10288, 10286, 10283, 10263, 10250, 10181, 10110, 10108, 10090, 10069, 10038, 10015, 10014, 10013
LIESENKOETTER	10108
LIFETEC	10293, 10264, 10249, 10171, 10170, 10127, 10118, 10108, 10074, 10064
LOEWE	10608, 10204, 10142, 10138, 10131
LOGIK	10757, 10680, 10649, 10630, 10606, 10587, 10264, 10187, 10070
LUMA	10249, 10229, 10197
LUMATRON	10249, 10229
LUXOR	10279, 10276, 10275, 10267, 10251, 10249, 10237, 10186, 10128, 10116, 10105, 10104, 10103, 10074, 10066, 10032
M ELECTRONIC	10276, 10127, 10120, 10105, 10104, 10103
M.D.C.	10074
MACROLUX	10069
MAGNADYNE	10204, 10185, 10164, 10163, 10108
MAGNAFON	10185
MAGNASONIC	10108
MAGNAVOX	10251
MAGNUM	10294, 10263, 10250, 10074, 10031
MANHATTAN	10264, 10249
MARANTZ	10108

MARSHAL	10064
MASCOM	10279, 10074, 10031
MASTERS	10108
MATSUI	10587, 10250, 10249, 10202, 10196, 10172, 10171, 10116, 10108, 10100, 10096, 10074, 10070, 10069, 10063, 10062, 10060, 10051, 10032, 10025
MAXELL	10249
MAXIM	10031
MEDION	10788, 10779, 10771, 10745, 10722, 10699, 10683, 10605, 10570, 10293, 10287, 10283, 10279, 10264, 10251, 10250, 10249, 10225, 10194, 10187, 10127, 10110, 10108, 10074, 10031
MEGAS	10273
MEMORY	10286
METEOR	10185
METZ	10736, 10265, 10264, 10254, 10249, 10219, 10108, 10101, 10100, 10097, 10096, 10092, 10074
MICROMAXX	10293, 10282, 10264, 10250, 10249, 10074
MIKOMI	10516, 10286
MINERVA	10232, 10172, 10100, 10097, 10092
MIRAI	10582
MITSAI	10110
MITSUBISHI	10249, 10224, 10204, 10120, 10119, 10097, 10077, 10076, 10075, 10071
MIVAR	10781, 10267, 10262, 10259, 10223, 10209
MMC2	10003, 10002, 10001
MORAVA	10249, 10152, 10109
MOSAIC	10264, 10249
MT LOGIC	10773, 10718, 10590, 10250
MTC	10131, 10086
MULTITEC	10264, 10249

MULTITECH	10267, 10185, 10171, 10108, 10090, 10085, 10031
MURPHY	10536, 10232
MURYUANA	10251
NAKIMURA	10170
NECKERMANN	10274, 10256, 10255, 10251, 10250, 10233, 10217, 10216, 10212, 10211, 10204, 10169, 10143, 10119, 10118, 10108, 10101, 10100, 10096, 10093, 10092, 10084, 10074, 10060, 10059, 10043, 10037
NEI	10108, 10064
NEUFUNK	10250, 10249, 10109
NEX	10448
NEXIUS	10282
NIKE	10108
NIKKAI	10219
NIKKEI	10264, 10249
NIKKO	10108
NISSAN	10268
NOBLIKO	10267, 10232, 10185
NOKIA	10719, 10653, 10645, 10279, 10276, 10275, 10251, 10106, 10105, 10104, 10103, 10102, 10074, 10032
NORDMENDE	10657, 10518, 10296, 10282, 10270, 10261, 10249, 10195, 10193, 10069
NORM N	10108
NORTEK	10264, 10249
NOVA	10087
NOVATRONIC	10108
OCEANIC	10276, 10104, 10103, 10032
ODYS	10782, 10727, 10697, 10677, 10674, 10656, 10647, 10642, 10633, 10632, 10610, 10566, 10526, 10525, 10519
OKANO	10255, 10108
ONWA	10280, 10108, 10064
OPERA	10250
ORAVA	10150, 10108, 10098, 10090

ORBITER	10086
ORION	10760, 10675, 10665, 10662, 10660, 10515, 10507, 10296, 10251, 10250, 10249, 10236, 10219, 10205, 10202, 10196, 10194, 10187, 10185, 10118, 10108, 10074, 10070, 10069, 10064, 10063, 10062, 10060, 10059, 10025
ORION (H)	10249, 10228, 10116, 10108, 10074, 10062
ORMOND	10249
OSAKI	10108
OTAKE	10196, 10060, 10059
OTF	10282, 10204, 10108, 10090
OTTO-VERSAND	10277, 10270, 10269, 10251, 10250, 10233, 10230, 10217, 10216, 10213, 10212, 10211, 10205, 10202, 10195, 10193, 10185, 10171, 10168, 10167, 10163, 10152, 10143, 10131, 10127, 10119, 10118, 10116, 10111, 10110, 10108, 10101, 10100, 10097, 10096, 10093, 10092, 10084, 10083, 10082, 10081, 10074, 10069, 10063, 10060, 10059, 10040, 10036, 10027, 10026
OVP	10108, 10098, 10090
PACIFIC	10250, 10249, 10236, 10109, 10063
PALLADIUM	10293, 10276, 10260, 10255, 10250, 10249, 10229, 10171, 10165, 10143, 10127, 10118, 10108, 10031
PANASONIC	10639, 10740, 10595, 10508, 10254, 10168, 10167
PEAQ	10716, 10668
PHILCO	10267, 10260, 10255, 10204, 10165, 10108

PHILIPS	10735, 10710, 10700, 10678, 10650, 10635, 10631, 10627, 10626, 10580, 10539, 10534, 10251, 10230, 10122, 10119, 10116, 10112, 10111, 10109, 10108, 10092, 10069, 10067, 10065, 10021, 10020, 10019, 10009, 10008, 10007
PHOCUS	10250, 10225, 10130, 10117
PHOENIX	10110, 10108, 10090
PIONEER	10193, 10108
PIONIER	10090
PLAYSONIC	10250, 10090
POWERPOINT	10172
PRANDONI	10069, 10066
PREMIER	10069
PRIMA	10219
PRIME	10697, 10249
PRIMUS	10251
PRO 2	10031
PROFEX	10267, 10171
PROFILO	10294, 10108, 10074, 10031
PROFITRONIC	10185, 10108
PROLINE	10286, 10285, 10270, 10269, 10249, 10229, 10205, 10189, 10128, 10120, 10109
PROSONIC	10637, 10636, 10625
PROTECH	10264, 10249, 10219, 10108, 10074
PROVISION	10282, 10120, 10109, 10108, 10066
PYE	10251, 10109, 10108
QMEDIA	10775, 10737, 10728, 10676
QUADRO	10293, 10286, 10249, 10123

QUELLE	10261, 10257, 10255, 10251, 10237, 10234, 10232, 10229, 10221, 10219, 10218, 10217, 10216, 10213, 10212, 10211, 10205, 10204, 10197, 10195, 10185, 10171, 10169, 10168, 10167, 10165, 10163, 10142, 10131, 10119, 10118, 10116, 10112, 10111, 10108, 10105, 10102, 10101, 10100, 10097, 10096, 10092, 10090, 10088, 10087, 10086, 10074, 10072, 10060, 10059, 10043, 10042, 10040, 10036, 10027, 10025	SAGEM	10273, 10206
RADIOLA	10251, 10108, 10067, 10065	SAISHO	10205, 10070, 10069, 10060, 10025
RADIOMARELLI	10164, 10108	SAKIO	10171
RADIONETTE	10181	SALORA	10767, 10751, 10687, 10590, 10535, 10279, 10276, 10275, 10251, 10249, 10237, 10143, 10128, 10116, 10105, 10104, 10103, 10074, 10066, 10032
RADIOTONE	10294, 10249, 10171, 10108, 10085, 10074	SAMBERS	10267, 10185
RANK	10232	SAMSUNG	10743, 10738, 10712, 10693, 10692, 10607, 10601, 10550, 10514, 10506, 10505, 10284, 10268, 10257, 10237, 10220, 10171, 10126, 10108, 10086, 10045
RECCO	10441	SANKYO	10108
RECOR	10249, 10108	SANSUI	10264, 10249, 10108
REDSTAR	10282	SANY	10193
REFLEX	10293, 10264, 10249, 10108	SANYO	10286, 10249, 10221, 10218, 10189, 10123, 10108, 10087, 10086, 10074, 10052, 10051, 10033, 10032, 10032
REFLEXION	10596	SCHAUB LORENZ	10537, 10531, 10296, 10277, 10275, 10264, 10250, 10249, 10171, 10117, 10116, 10108, 10074
REOC	10250	SCHNEIDER	10702, 10621, 10324, 10282, 10269, 10264, 10251, 10250, 10249, 10233, 10163, 10152, 10127, 10116, 10108, 10088, 10069, 10064, 10063
REVOX	10131	SCHNEIDER (F)	10251, 10067, 10065
REX	10197, 10164, 10089, 10088	SCOTT	10648, 10638, 10593
RFT	10204, 10116, 10085, 10064	SEELVER	10069
RM 2000	10264, 10249, 10108	SEG	10756, 10747, 10655, 10573, 10560, 10559, 10517, 10293, 10286, 10269, 10267, 10264, 10249, 10219, 10185, 10171, 10165, 10123, 10115, 10108, 10064
ROADSTAR	10286, 10280, 10264, 10263, 10251, 10250, 10249, 10117, 10108, 10090, 10069, 10063	SEITECH	10282
ROBOTRON	10204		
ROSITA	10171		
ROWA	10283, 10249		
ROYAL	10277		
ROYAL LUX	10282		
SABA	10270, 10249, 10195, 10193, 10074		

SELECO	10251, 10249, 10229, 10226, 10197, 10195, 10110, 10109, 10089, 10088
SELECT	10264
SENCOR	10117
SENTRA	10064, 10049
SERINO	10273
SET	10074
SHARP	10646, 10749, 10748, 10714, 10644, 10568, 10567, 10558, 10557, 10556, 10432, 10423, 10224, 10171, 10084, 10083, 10082, 10081, 10073
SHINTOM	10249, 10108
SHINTOSHI	10108
SHIVAKI	10264, 10249, 10108
SIAREM	10204, 10185
SIEMENS	10554, 10294, 10256, 10221, 10219, 10218, 10101, 10100, 10097, 10096, 10093, 10092, 10074
SIERA	10069
SILVA SCHNEIDER	10597, 10294, 10286, 10282, 10074, 10031
SILVER	10277, 10224, 10171, 10074, 10064
SILVERCREST	10780
SIM2	10226
SINGER	10251, 10204, 10185, 10164, 10108, 10069
SINUDYNE	10282, 10251, 10249, 10212, 10204, 10196, 10185, 10118, 10074, 10069, 10063, 10062, 10025
SKY	10207, 10194, 10187
SLX	10264
SMARAGD	10172
SONIX	10194
SONOKO	10249
SONTEC	10108
SONY	10739, 10538, 10217, 10216, 10215, 10214, 10213, 10212, 10211, 10072

SOUNDCOLOR	10264, 10249, 10108, 10074
SOXO	10545
SPECTRA	10170
STANDARD	10108
STARLITE	10264, 10171, 10108
STARLUX	10171
STARS	10251
STERN	10229, 10197, 10089, 10088
STRONG	10286, 10123, 10115,
SUNGOO	10672
SUNKAI	10273
SUNSTAR	10171, 10108, 10074,
SUNSTECH	10783, 10671
SUPERIOR	10286
SUPERTECH	10249, 10171, 10108, 10074
SUPRATECH	10670, 10620, 10619,
SUPREMA	10273
SWISSTEC	10704, 10603, 10574, 10309, 10207, 10194, 10187
TADISTAR	10108
TANDBERG	10254
TASHIKO	10224, 10218
TATUNG	10286, 10282, 10189, 10184, 10128, 10118, 10108, 10079, 10070, 10069, 1066, 10063
TAURAS	10762, 10282
TCL	10716, 10668, 10565, 10564, 10563, 10562, 10561, 10152,
TCM	10127
TD DESIGN	10131
TEAC	10661
TEC	10264, 10249, 10171, 10170, 10166, 10165, 10108
TECHLINE	10293, 10264, 10249, 10185, 10123, 10108
TECHNICA	10286, 10282, 10249
TECHNIKA	10715, 10600, 10585, 10584, 10547
TECHNISAT	10695, 10694, 10571, 10248, 10118, 10108
TECHWOOD	10249, 10123, 10115
TECNIMAGEN	10251, 10069

TECNISON	10249, 10171, 10108	TOKYO	10268
TECSONIC	10249	TOPLINE	10264, 10249
TEKON	10268, 10171	TOPVISION	10085
TELEFUNKEN	10688, 10679, 10530, 10270, 10261, 10225, 10195, 10193	TOSHIBA	10663, 10769, 10768, 10729, 10711, 10616, 10615, 10614, 10613, 10523, 10522, 10520, 10284, 10268, 10250, 10249, 10232, 10208, 10203, 10202, 10100, 10092, 10063, 10050, 10049, 10048, 10047, 10045, 10043, 10042, 10037, 10036, 10027, 10026
TELEOPTA	10171	TOSUMI	10250
TELERENT	10233, 10131	TOWADA	10185
TELESTAR	10294, 10282, 10227, 10108, 10074, 10031	TRANS-CONTINENTS	10069
TELETECH	10264, 10249, 10171, 10165, 10108	TRILUX	10292, 10264, 10120
TELETON	10197, 10089, 10088	TRISTAR	10064
TELEVIEW	10031	TRIUMPH	10234, 10219, 10025
TELRA	10294, 10108, 10074, 10031	TVE	10249
TENSAI	10264, 10249, 10191, 10171, 10127, 10120, 10110, 10108, 10064	TWF	10320
TENSON	10171	UHER	10249, 10233, 10197, 10185, 10131, 10108, 10089
TESLA	10282, 10273, 10264, 10263, 10250, 10249, 10229, 10204, 10150, 10127, 10116, 10109, 10108, 10090, 10074, 10069	ULTRAVOX	10204, 10185, 10164, 10108
TEVION	10771, 10583, 10294, 10287, 10264, 10250, 10249, 10225, 10127	UMC	10723, 10715, 10704, 10661, 10609, 10606, 10603, 10600, 10599, 10585, 10584, 10579, 10547, 10528
THOMSON	10716, 10668, 10565, 10564, 10563, 10562, 10561, 10270, 10261, 10195, 10193	UNIMOR	10086, 10085
THOMSON IR2000	10006, 10005, 10004	UNITED	10705, 10610, 10596, 10286, 10282, 10263, 10250, 10170, 10108, 10090, 10063
THOMSON REC 80	10012, 10011, 10010	UNIVERSUM	10293, 10286, 10279, 10276, 10275, 10274, 10270, 10264, 10260, 10249, 10237, 10234, 10229, 10227, 10219, 10218, 10171, 10123, 10116, 10109, 10108, 10105, 10104, 10103, 10102, 10100, 10097, 10087, 10086, 10074, 10025
THORN	10270, 10251, 10232, 10224, 10216, 10213, 10211, 10195, 10189, 10188, 10170, 10169, 10168, 10128, 10120, 10116, 10110, 10108, 10107, 10106, 10105, 10102, 10097, 10087, 10079, 10078, 10075, 10072, 10067, 10065, 10052, 10049, 10045, 10043, 10036, 10033, 10032, 10028, 10026	UNIVOX	10204
THORN-FERGUSON	10195, 10188		
TOBO	10171		

VESTEL	10701, 10513, 10303, 10293, 10286, 10264, 10249, 10123, 10121, 10115, 10108
VESTL	10433
VIDEOCON	10658, 10657, 10651, 10424
VIDEOSAT	10165
VIDEOSEVEN	10194, 10187
VIDEOTON	10249, 10193
VIEWSON	10450, 10449, 10447, 10445, 10444, 10443,
VIEWPIA	10730, 10641
VISION	10249, 10108
VISIONMAGIC	10187
VOG	10069
VOXSON	10204
WALKER	10286
WALTHAM	10171
WATSON	10293, 10264, 10249, 10194, 10171, 10127, 10108, 10074, 10064
WATT RADIO	10185
WEGAVOX	10282, 10264, 10249
WELLTECH	10250
WELTBlick	10110, 10108
WHARFEDALE	10524, 10313
WHITE WESTINGHOUSE	10260, 10110, 10108
WIEWPIA	10427
WILSON	10569, 10249
WINSON	10250
WORTEN	10273, 10229, 10120, 10110
XENIUS	10298
XIRON	10731, 10303
YAMO	10064
YOKO	10274, 10171, 10170, 10164, 10108, 10064
ZANELA	10224
ZANUSSI	10197

V. Copyright - GNU GPL

GNU GENERAL PUBLIC LICENSE

Version 2, June 1991

Copyright (C) 1989, 1991 Free Software Foundation, Inc.

51 Franklin Street, Fifth Floor, Boston, MA 02110-1301, USA

Everyone is permitted to copy and distribute verbatim copies of this license document, but changing it is not allowed.

Preamble

The licenses for most software are designed to take away your freedom to share and change it. By contrast, the GNU General Public License is intended to guarantee your freedom to share and change free software—to make sure the software is free for all its users. This General Public License applies to most of the Free Software Foundation's software and to any other program whose authors commit to using it. (Some other Free Software Foundation software is covered by the GNU Lesser General Public License instead.) You can apply it to your programs, too.

When we speak of free software, we are referring to freedom, not price. Our General Public Licenses are designed to make sure that you have the freedom to distribute copies of free software (and charge for this service if you wish), that you receive source code or can get it if you want it, that you can change the software or use pieces of it in new free programs; and that you know you can do these things.

To protect your rights, we need to make restrictions that forbid anyone to deny you these rights or to ask you to surrender the rights. These restrictions translate to certain responsibilities for you if you distribute copies of the software, or if you modify it.

For example, if you distribute copies of such a program, whether gratis or for a fee, you must give the recipients all the rights that you have. You must make sure that they, too, receive or can get the source code. And you must show them these terms so they know their rights.

We protect your rights with two steps: (1) copyright the software, and (2) offer you this license which gives you legal permission to copy, distribute and/or modify the software.

Also, for each author's protection and ours, we want to make certain that everyone understands that there is no warranty for this free software. If the software is modified by someone else and passed on, we want its recipients to know that what they have is not the original, so that any problems introduced by others will not reflect on the original authors' reputations.

Finally, any free program is threatened constantly by software patents. We wish to avoid the danger that redistributors of a free program will individually obtain patent licenses, in effect making the program proprietary. To prevent this, we have made it clear that any patent must be licensed for everyone's free use or not licensed at all.

The precise terms and conditions for copying, distribution and modification follow.

TERMS AND CONDITIONS FOR COPYING, DISTRIBUTION AND MODIFICATION

0. This License applies to any program or other work which contains a notice placed by the copyright holder saying it may be distributed under the terms of this General Public License. The "Program", below, refers to any such program or work, and a "work based on the Program" means either the Program or any derivative work under copyright law: that is to say, a work containing the Program or a portion of it, either verbatim or with modifications and/or translated into another language. (Hereinafter, translation is included without limitation in the term "modification".) Each licensee is addressed as "you".

Activities other than copying, distribution and modification are not covered by this License; they are outside its scope. The act of running the Program is not restricted, and the output from the Program is covered only if its contents constitute a work based on the Program (independent of having been made by running the Program). Whether that is true depends on what the Program does.

1. You may copy and distribute verbatim copies of the Program's source code as you receive it, in any medium, provided that you conspicuously and appropriately publish on each copy an appropriate copyright notice and disclaimer of warranty; keep intact all the notices that refer to this License and to the absence of any warranty; and give any other recipients of the Program a copy of this License along with the Program. You may charge a fee for the physical act of transferring a copy, and you may at your option offer warranty protection in exchange for a fee.

2. You may modify your copy or copies of the Program or any portion of it, thus forming a work based on the Program, and copy and distribute such modifications or work under the terms of Section 1 above, provided that you also meet all of these conditions:

- a) You must cause the modified files to carry prominent notices stating that you changed the files and the date of any change.
- b) You must cause any work that you distribute or publish, that in whole or in part contains or is derived from the Program or any part thereof, to be licensed as a whole at no charge to all third parties under the terms of this License.
- c) If the modified program normally reads commands interactively when run, you must cause it, when started running for such interactive use in the most ordinary way, to print or display an announcement including an appropriate copyright notice and a notice that there is no warranty (or else, saying that you provide a warranty) and that users may redistribute the program under these conditions, and telling the user how to view a copy of this License. (Exception: if the Program itself is interactive but does not normally print such an announcement, your work based on the Program is not required to print an announcement.)

These requirements apply to the modified work as a whole. If identifiable sections of that work are not derived from the Program, and can be reasonably considered independent and separate works in themselves, then this License, and its terms, do not apply to those sections when you distribute them as separate works. But when you distribute the same sections as part of a whole which is a work based on the Program, the distribution of the whole must be on the terms of this License, whose permissions for other licensees extend to the entire whole, and thus to each and every part regardless of who wrote it. Thus, it is not the intent of this section to claim rights or contest your rights to work written entirely by you; rather, the intent is to exercise the right to control the distribution of derivative or collective works based on the Program.

In addition, mere aggregation of another work not based on the Program with the Program (or with a work based on the Program) on a volume of a storage or distribution medium does not bring the other work under the scope of this License.

3. You may copy and distribute the Program (or a work based on it, under Section 2) in object code or executable form under the terms of Sections 1 and 2 above provided that you also do one of the following:

- a) Accompany it with the complete corresponding machine-readable source code, which must be distributed under the terms of Sections 1 and 2 above on a medium customarily used for software interchange; or,
- b) Accompany it with a written offer, valid for at least three years, to give any third party, for a charge no more than your cost of physically performing source distribution, a complete machine-readable copy of the corresponding source code, to be distributed under the terms of Sections 1 and 2 above on a medium customarily used for software interchange; or,

c) Accompany it with the information you received as to the offer to distribute corresponding source code. (This alternative is allowed only for noncommercial distribution and only if you received the program in object code or executable form with such an offer, in accord with Subsection b above.)

The source code for a work means the preferred form of the work for making modifications to it. For an executable work, complete source code means all the source code for all modules it contains, plus any associated interface definition files, plus the scripts used to control compilation and installation of the executable. However, as a special exception, the source code distributed need not include anything that is normally distributed (in either source or binary form) with the major components (compiler, kernel, and so on) of the operating system on which the executable runs, unless that component itself accompanies the executable.

If distribution of executable or object code is made by offering access to copy from a designated place, then offering equivalent access to copy the source code from the same place counts as distribution of the source code, even though third parties are not compelled to copy the source along with the object code.

4. You may not copy, modify, sublicense, or distribute the Program except as expressly provided under this License. Any attempt otherwise to copy, modify, sublicense or distribute the Program is void, and will automatically terminate your rights under this License. However, parties who have received copies, or rights, from you under this License will not have their licenses terminated so long as such parties remain in full compliance.

5. You are not required to accept this License, since you have not signed it. However, nothing else grants you permission to modify or distribute the Program or its derivative works. These actions are prohibited by law if you do not accept this License. Therefore, by modifying or distributing the Program (or any work based on the Program), you indicate your acceptance of this License to do so, and all its terms and conditions for copying, distributing or modifying the Program or works based on it.

6. Each time you redistribute the Program (or any work based on the Program), the recipient automatically receives a license from the original licensor to copy, distribute or modify the Program subject to these terms and conditions. You may not impose any further restrictions on the recipients' exercise of the rights granted herein. You are not responsible for enforcing compliance by third parties to this License.

7. If, as a consequence of a court judgment or allegation of patent infringement or for any other reason (not limited to patent issues), conditions are imposed on you (whether by court order, agreement or otherwise) that contradict the conditions of this License, they do not excuse you from the conditions of this License. If you cannot distribute so as to satisfy simultaneously your obligations under this License and any other pertinent obligations, then as a consequence you may not distribute the Program at all. For example, if a patent license would not permit royalty-free redistribution of the Program by all those who receive copies directly or indirectly through you, then the only way you could satisfy both it and this License would be to refrain entirely from distribution of the Program.

If any portion of this section is held invalid or unenforceable under any particular circumstance, the balance of the section is intended to apply and the section as a whole is intended to apply in other circumstances.

It is not the purpose of this section to induce you to infringe any patents or other property right claims or to contest validity of any such claims; this section has the sole purpose of protecting the integrity of the free software distribution system, which is implemented by public license practices. Many people have made generous contributions to the wide range of software distributed through that system in reliance on consistent application of that system; it is up to the author/donor to decide if he or she is willing to distribute software through any other system and a licensee cannot impose that choice.

This section is intended to make thoroughly clear what is believed to be a consequence of the rest of this License.

8. If the distribution and/or use of the Program is restricted in certain countries either by patents or by copyrighted interfaces, the original copyright holder who places the Program under this License may add an explicit geographical distribution limitation excluding those countries, so that distribution is permitted only in or among countries not thus excluded. In such case, this License incorporates the limitation as if written in the body of this License.

9. The Free Software Foundation may publish revised and/or new versions of the General Public License from time to time. Such new versions will be similar in spirit to the present version, but may differ in detail to address new problems or concerns.

Each version is given a distinguishing version number. If the Program specifies a version number of this License which applies to it and "any later version", you have the option of following the terms and conditions either of that version or of any later version published by the Free Software Foundation. If the Program does not specify a version number of this License, you may choose any version ever published by the Free Software Foundation.

10. If you wish to incorporate parts of the Program into other free programs whose distribution conditions are different, write to the author to ask for permission. For software which is copyrighted by the Free Software Foundation, write to the Free Software Foundation; we sometimes make exceptions for this. Our decision will be guided by the two goals of preserving the free status of all derivatives of our free software and of promoting the sharing and reuse of software generally.

No warranty

11. Because the program is licensed free of charge, there is no warranty for the program, to the extent permitted by applicable law. Except when otherwise stated in writing the copyright holders and/or other parties provide the program "as is" without warranty of any kind, either expressed or implied, including, but not limited to, the implied warranties of merchantability and fitness for a particular purpose. The entire risk as to the quality and performance of the program is with you. Should the program prove defective, you assume the cost of all necessary servicing, repair or correction.

12. In no event unless required by applicable law or agreed to in writing will any copyright holder, or any other party who may modify and/or redistribute the program as permitted above, be liable to you for damages, including any general, special, incidental or consequential damages arising out of the use or inability to use the program (including but not limited to loss of data or data being rendered inaccurate or losses sustained by you or third parties or a failure of the program to operate with any other programs), even if such holder or other party has been advised of the possibility of such damages.

End of terms and conditions

VI. Menu Structure

Main menu					
1st level	2nd level	3rd level	4nd level	5nd level	
Media player	Media Player				
Timer	Timer List				
Information	Service	Service info			
	About	About			
Plugins	Plugin browser				
Setup	Service Searching	Tuner Configuration	Tuner A,B,C		
		Default Service lists			
		Automatic Scan	Service scan Window		
		Manual Scan	Service scan Window		
		Language	Language	Language Selection Window	
			Customize	Customize Window	
			Timezone	Timezone Window	
		Harddisk	Harddisk setup	Harddisk setup	Harddisk setup
			Initialization	Initialization	Initialization
			Filesystem Check	Filesystem Check	Filesystem Check
		A/V Settings	A/V Settings Window		
		Display Setup	Display Setup Window		
		Network	Network Configuration Window		
		Keyboard	Keyboard Setup Window		
	Skin				
	Common Interface				
	Parental control	Parental control setup			
Factory reset					
Idle Server Mode / Restart	Sleep Timer				
	Idle Server Mode				
	Restart				
	Standby				

VII. Troubleshooting

Before you contact your local service center, please read the following tips carefully.

NOTE : if the antenna is covered with snow or the RF signal is weakened by heavy rain, the quality of audio and video may become temporarily poor. If you experience poor audio and video quality due to bad weather conditions, please check if your satellite antenna is oriented in the original direction. And see if it is covered by snow. Also, check if your LNB is not damaged.

1. No video on TV

- Check first if the product is powered on and in operation mode.
- Check if the video cable is properly connected between TV and Vu+.
- Check if the satellite cable is properly connected to Vu+.
- Check if the selected channel is currently on air.
- Check if the selected channel is encrypted and if you have a corresponding access smartcard.

2. Problem with audio quality

- Check if your audio cable is connected correctly.
- Check the volume level of your TV and Vu+.
- Check if Vu+ or TV is on mute.
- Check the audio option if it is correctly selected for the program that you are currently watching.

3. Remote control problem

- Check if the batteries are correctly mounted.
- If your remote control has been used for long, change the batteries.
- Point the remote control directly toward Vu+.
- Make sure that nothing blocks the front panel display.

4. Channel search problem

- Make sure if tuner configurations are all correctly made.
- Check if the antenna cable(s) are properly connected.

5. Encrypted channel viewing problem

- Check if you have the appropriate Smartcard and/or CAM.
- Take the Smartcard and CAM out and re-insert them to re-initialize.
- Check if your system correctly detects the smartcard and CAM.

6. Recording problem

- Check if the HDD has a sufficient space for recording.
- Check if there is a conflict between recording timer.

7. Noise

- when HDD is running, you may hear a noise.

VIII. Glossary

8PSK	8-PSK is usually the highest order PSK constellation deployed. With more than 8 phases, the error-rate becomes too high and there are better, though more complex, modulations available such as quadrature amplitude modulation (QAM). Although any number of phases may be used, the fact that the constellation must usually deal with binary data means that the number of symbols is usually a power of 2 — this allows an equal number of bits-per-symbol.
CAM	Conditional Access Module is an electronic device, usually incorporating a slot for a smart card, which equips an Integrated Digital Television or set-top box with the appropriate hardware facility to view conditional access content that has been encrypted using a conditional access system. They are normally used with direct broadcast satellite (DBS) services.
Composite Video	Composite video is the format of an analog television (picture only) signal before it is combined with a sound signal and modulated onto an RF carrier. Composite video is often designated by the CVBS acronym, meaning "Color, Video, Blank and Sync". In German (with PAL being a German invention by Telefunken's Walter Bruch) the abbreviation FBAS (Farbe-Bild-Austastung-Synchron) means the same. It is usually in standard formats such as NTSC, PAL, and SECAM. It is a composite of three source signals called Y, U and V (together referred to as YUV) with sync pulses. Y represents the brightness or luminance of the picture and includes synchronizing pulses, so that by itself it could be displayed as a monochrome picture. U and V represent hue and saturation or chrominance; between them they carry the color information. They are first modulated on two orthogonal phases of a color carrier signal to form a signal called the chrominance. Y and UV are then combined. Since Y is a baseband signal and UV has been mixed with a carrier, this addition is equivalent to frequency-division multiplexing.
Conditional Access System	Several companies provide competing Conditional Access Systems; Irdeto Access, Nagravision, Viaccess, Verimatrix and NDS are among the most commonly used CAS systems.
DiSEqC	Stands for Digital Satellite Equipment Control. It is a special communication protocol for use between a satellite receiver and a device such as a multi-dish switch or a small dish antenna rotor. DiSEqC was developed by European satellite provider Eutelsat, which now acts as the standards agency for the protocol.
EPG	Electronic Program Guide is a digital guide to scheduled broadcast television or radio programs, typically displayed on-screen with functions allowing a viewer to navigate, select, and discover content by time, title, channel, genre, etc. by use of their remote control, a keyboard, or other input devices such as a phone keypad. Content can also be scheduled for future recording by a personal video recorder (PVR). The on-screen information may be delivered by a dedicated channel or assembled by the receiving equipment from information sent by each program channel.

eSATA	A variant of SATA meant for external connectivity with the following characteristics: * Minimum transmit potential: Range is 500–600 mV. * Minimum receive potential: Range is 240–600 mV. * Identical protocol and logical signaling (link/transport-layer and above), allowing native SATA devices to be deployed in external enclosures with minimal modification.
FEC	Stands for Forward Error Correction. This is a system of error control for data transmission, whereby the sender adds redundant data to its messages, also known as an error-correction code. This allows the receiver to detect and correct errors (within some bound) without the need to ask the sender for additional data. The advantages of forward error correction are that a back-channel is not required and retransmission of data can often be avoided (at the cost of higher bandwidth requirements, on average).
HDMI	Stands for High-Definition Multimedia Interface. It is a compact audio/video interface for transmitting uncompressed digital data. HDMI connects digital audio/video sources—such as set-top boxes, Blu-ray Disc players, personal computers (PCs), video game consoles (such as the PlayStation 3 and some models of Xbox 360), and AV receivers—to compatible digital audio devices, computer monitors, and digital televisions. As an uncompressed connection, HDMI is independent of the various digital television standards used by individual devices, such as ATSC and DVB, as these are encapsulations of compressed MPEG video streams (which can be decoded and output as an uncompressed video stream on HDMI).
LNB	Stands for Low-Noise Block converter. This is the (receiving, or downlink) antenna of what is commonly called the parabolic satellite dish commonly used for satellite TV reception. The LNB is usually fixed on or in the satellite dish. The purpose of the LNB is to take a wide block (or band) of relatively high frequencies, amplify and convert them to similar signals carried at a much lower frequency (called intermediate frequency or IF). These lower frequencies travel through cables with much less attenuation of the signal, so there is much more signal left on the satellite receiver end of the cable. It is also much easier and cheaper to design electronic circuits to operate at these lower frequencies, rather than the very high frequencies of satellite transmission.
PID	Stands for Packet Identifier. This is a set of numbers identifying stream packets contained within a single data stream
Polarization	The orientation of the electrical and magnetic fields of a signal. Satellites use mainly vertical and horizontal polarization.
S/PDIF	Stands for Sony/Philips Digital Interconnect Format. A common use for the S/PDIF interface is to carry compressed digital audio as defined by the standard IEC 61937. This mode is used to connect the output of a DVD player to a home theater. Another common use is to carry uncompressed digital audio from a CD player to a receiver. This specification also allows for the coupling of personal computer digital sound (if equipped) via optical or coax to receivers.

SCART	A French-originated standard and associated 21-pin connector for connecting audio-visual (AV) equipment together. SCART is one of the most common method of connecting audio-visual equipment together. However, transferring analogue standard-definition content, SCART is becoming obsolete with the introduction of new digital standards such as HDMI, which can also carry high-definition content and multichannel audio.
Smartcard	A pocket-sized card with embedded Integrated Circuits which can process data. It can receive input which is processed and delivered as an output. The card may embed a hologram to avoid counterfeiting. It is used for accessing encrypted TV channels or services.
Teletext	A television information retrieval service developed in the United Kingdom in the early 1970s. It offers a range of text-based information, typically including national, international and sporting news, weather and TV schedules. Subtitle (or closed captioning) information is also transmitted in the teletext signal, typically on page 888 or 777.
Xcrypt	One of the Conditional Access Systems by Xcrypt.
YPbPr	<p>A color space used in video electronics, in particular in reference to component video cables. YPbPr is the analog version of the YCBCR color space; the two are numerically equivalent, but YPBPR is designed for use in analog systems whereas YCBCR is intended for digital video. YPbPr is commonly called "component video", but this is a misnomer, as there are many other types of component video (mostly RGB with sync either on green or one or two separate signals).</p> <p>YPbPr is converted from the RGB video signal, which is split into three components, Y, PB, and PR.</p> <ul style="list-style-type: none"> * Y carries luma (brightness) and sync information. * PB carries the difference between blue and luma (B - Y). * PR carries the difference between red and luma (R - Y). <p>Sending a green signal would be redundant, as it can be derived using the blue, red and luma information.</p>